

PRODUCT MONOGRAPH  
INCLUDING PATIENT MEDICATION INFORMATION

PrHYRIMOZ®

Adalimumab injection

20 mg in 0.4 mL sterile solution (50 mg/mL) subcutaneous injection in pre-filled syringe  
40 mg in 0.8 mL sterile solution (50 mg/mL) subcutaneous injection in a pre-filled syringe  
40 mg in 0.8 mL sterile solution (50 mg/mL) subcutaneous injection in a pre-filled autoinjector

Biological Response Modifier

**HYRIMOZ® (adalimumab) treatment should be initiated and supervised by specialist physicians experienced in the diagnosis and treatment of rheumatoid arthritis, polyarticular juvenile idiopathic arthritis, psoriatic arthritis, ankylosing spondylitis, adult Crohn's disease, ulcerative colitis, hidradenitis suppurativa, psoriasis or adult uveitis, and familiar with the HYRIMOZ® efficacy and safety profile.**

Sandoz Canada Inc.  
110 de rue Lauzon  
Boucherville, Québec  
J4B 1E6

Date of Initial Approval:  
November 04, 2020

Submission Control No: 217314, 235712

## TABLE OF CONTENTS

<b>PART I: HEALTH PROFESSIONAL INFORMATION.....</b>	<b>4</b>
<b>1 INDICATIONS.....</b>	<b>4</b>
1.1 Pediatrics.....	5
1.2 Geriatrics.....	6
<b>2 CONTRAINDICATIONS.....</b>	<b>6</b>
<b>3 SERIOUS WARNINGS AND PRECAUTIONS BOX.....</b>	<b>6</b>
<b>4 DOSAGE AND ADMINISTRATION.....</b>	<b>7</b>
4.1 Dosing Considerations.....	7
4.2 Recommended Dose and Dosage Adjustment.....	8
4.3 Administration.....	11
4.4 Missed Dose.....	11
<b>5 OVERDOSAGE.....</b>	<b>12</b>
<b>6 DOSAGE FORMS, STRENGTHS, COMPOSITION AND PACKAGING.....</b>	<b>12</b>
<b>7 DESCRIPTION.....</b>	<b>13</b>
<b>8 WARNINGS AND PRECAUTIONS.....</b>	<b>13</b>
8.1 Special Populations.....	20
8.1.1 Pregnant Women.....	20
8.1.2 Nursing Women.....	21
8.1.3 Pediatrics.....	21
8.1.4 Geriatrics (>65 years of age).....	21
<b>9 ADVERSE REACTIONS.....</b>	<b>22</b>
9.1 Adverse Reaction Overview.....	22
9.2 Clinical Trial Adverse Reactions.....	29
9.3 Less Common Clinical Trial Adverse Reactions.....	44
9.4 Abnormal Laboratory Findings: Hematologic, Clinical Chemistry and Other Quantitative Data.....	46
9.5 Post-Market Adverse Reactions.....	47
<b>10 DRUG INTERACTIONS.....</b>	<b>48</b>
10.1 Serious Drug Interactions Box.....	48
10.2 Overview.....	48
10.3 Drug-Drug Interactions.....	49
10.4 Drug-Food Interactions.....	49
10.5 Drug-Herb Interactions.....	49
10.6 Drug-Laboratory Test Interactions.....	50
10.7 Drug-Lifestyle Interactions.....	50
<b>11 ACTION AND CLINICAL PHARMACOLOGY.....</b>	<b>50</b>
11.1 Mechanism of Action.....	50
11.2 Pharmacodynamics.....	50
11.3 Pharmacokinetics.....	51

<b>12</b>	<b>STORAGE, STABILITY AND DISPOSAL.....</b>	<b>54</b>
<b>13</b>	<b>SPECIAL HANDLING INSTRUCTIONS.....</b>	<b>54</b>
	<b>PART II: SCIENTIFIC INFORMATION .....</b>	<b>55</b>
<b>14</b>	<b>PHARMACEUTICAL INFORMATION.....</b>	<b>55</b>
<b>15</b>	<b>COMPARATIVE CLINICAL TRIALS.....</b>	<b>56</b>
15.1	Comparative Trial Design and Study Demographics .....	56
15.2	Comparative Study Results .....	58
15.2.1	Comparative Bioavailability Studies .....	58
15.2.1.1	Pharmacokinetics .....	58
15.2.2	Comparative Safety and Efficacy .....	58
15.2.2.1	Efficacy .....	58
15.2.2.2	Safety .....	59
15.2.2.3	Immunogenicity .....	60
<b>16</b>	<b>COMPARATIVE NON-CLINICAL PHARMACOLOGY AND TOXICOLOGY.....</b>	<b>60</b>
16.1	Comparative Non-Clinical Pharmacodynamics.....	60
16.2	Comparative Non-Clinical Toxicology.....	61
<b>17</b>	<b>CLINICAL TRIALS – REFERENCE BIOLOGIC DRUG .....</b>	<b>62</b>
<b>18</b>	<b>NON-CLINICAL TOXICOLOGY – REFERENCE BIOLOGIC DRUG.....</b>	<b>102</b>
<b>19</b>	<b>SUPPORTING PRODUCT MONOGRAPHS .....</b>	<b>107</b>
	<b>PATIENT MEDICATION INFORMATION .....</b>	<b>108</b>
	<b>PATIENT MEDICATION INFORMATION .....</b>	<b>122</b>
	<b>PATIENT MEDICATION INFORMATION .....</b>	<b>136</b>

HYRIMOZ<sup>®</sup> (adalimumab) is a biosimilar biologic drug (biosimilar) to HUMIRA<sup>®</sup>.

## **PART I: HEALTH PROFESSIONAL INFORMATION**

### **1 INDICATIONS**

Indications have been granted on the basis of similarity between HYRIMOZ<sup>®</sup> and the reference biologic drug HUMIRA<sup>®</sup>.

**HYRIMOZ (adalimumab injection) treatment should be initiated and supervised by specialist physicians experienced in the diagnosis and treatment of rheumatoid arthritis (RA), polyarticular juvenile idiopathic arthritis (JIA), psoriatic arthritis (PsA), ankylosing spondylitis (AS), adult Crohn's disease (CD), ulcerative colitis (UC), hidradenitis suppurativa (HS), psoriasis (Ps) or adult uveitis, and familiar with the HYRIMOZ efficacy and safety profile.**

HYRIMOZ is indicated for:

#### **Rheumatoid Arthritis**

- reducing the signs and symptoms, inducing major clinical response and clinical remission, inhibiting the progression of structural damage and improving physical function in adult patients with moderately to severely active rheumatoid arthritis. HYRIMOZ can be used alone or in combination with methotrexate (MTX) or other disease-modifying anti-rheumatic drugs (DMARDs).

When used as first-line treatment in recently diagnosed patients who have not been previously treated with methotrexate, HYRIMOZ should be given in combination with methotrexate. HYRIMOZ can be given as monotherapy in case of intolerance to methotrexate or when treatment with methotrexate is contraindicated.

#### **Polyarticular Juvenile Idiopathic Arthritis**

- in combination with methotrexate, reducing signs and symptoms of moderately to severely active polyarticular juvenile idiopathic arthritis in patients, 2 years of age and older who have had an inadequate response to one or more disease-modifying antirheumatic drugs (DMARDs). HYRIMOZ can be used as monotherapy in case of intolerance to methotrexate or when continued treatment with methotrexate is not appropriate (see CLINICAL TRIALS, Pediatric, Polyarticular Juvenile Idiopathic Arthritis, Study Results). Adalimumab has not been studied in pediatric patients with polyarticular juvenile idiopathic arthritis aged less than 2 years.

#### **Psoriatic Arthritis**

- reducing the signs and symptoms of active arthritis and inhibiting the progression of structural damage and improving the physical function in adult psoriatic arthritis patients. HYRIMOZ can be used in combination with methotrexate (MTX) in patients who do not respond adequately to methotrexate alone.

### **Ankylosing Spondylitis**

- reducing signs and symptoms in patients with active ankylosing spondylitis who have had an inadequate response to conventional therapy.

### **Adult Crohn's Disease**

- reducing signs and symptoms and inducing and maintaining clinical remission in adult patients with moderately to severely active Crohn's disease who have had an inadequate response to conventional therapy, including corticosteroids and/or immunosuppressants. HYRIMOZ is indicated for reducing signs and symptoms and inducing clinical remission in these patients if they have also lost response to or are intolerant to infliximab.

### **Ulcerative Colitis**

- treatment of adult patients with moderately to severely active ulcerative colitis (UC) who have had an inadequate response to conventional therapy including corticosteroids and/or azathioprine or 6-mercaptopurine (6-MP) or who are intolerant to such therapies. The efficacy of adalimumab in patients who have lost response to or were intolerant to TNF blockers has not been established.

### **Hidradenitis Suppurativa**

- treatment of active moderate to severe hidradenitis suppurativa in adult patients, who have not responded to conventional therapy (including systemic antibiotics).

### **Plaque Psoriasis**

- treatment of adult patients with chronic moderate to severe plaque psoriasis who are candidates for systemic therapy. For patients with chronic moderate plaque psoriasis, HYRIMOZ should be used after phototherapy has been shown to be ineffective or inappropriate.

### **Adult Uveitis**

- treatment of non-infectious uveitis (intermediate, posterior and panuveitis) in adult patients with inadequate response to corticosteroids or as corticosteroid sparing treatment in corticosteroid-dependent patients.

## **1.1 Pediatrics**

### **Pediatrics (< 18 years of age):**

#### **Polyarticular JIA**

Adalimumab has not been studied in pediatric patients with polyarticular JIA less than 2 years of age or in pediatric patients with a weight below 10 kg.

## 1.2 Geriatrics

### Geriatrics (> 65 years of age):

Evidence from clinical studies and experience suggests that use of adalimumab in the geriatric population is not associated with differences in effectiveness. A brief discussion can be found under (WARNINGS AND PRECAUTIONS, Special Populations, Geriatrics).

## 2 CONTRAINDICATIONS

- Patients with known hypersensitivity to HYRIMOZ (adalimumab injection) or any of its components. For a complete listing, see the (DOSAGE FORMS, COMPOSITION AND PACKAGING) section.
- Patients with severe infections such as sepsis, tuberculosis and opportunistic infections. See (WARNINGS AND PRECAUTIONS, Serious Warnings and Precautions, Infections).
- Patients with moderate to severe heart failure (NYHA class III/IV). See (WARNINGS AND PRECAUTIONS, Cardiovascular, Patients with Congestive Heart Failure).

## 3 SERIOUS WARNINGS AND PRECAUTIONS BOX

### Serious Warnings and Precautions

#### **Hepatosplenic T-Cell Lymphoma**

Very rare post-marketing reports of hepatosplenic T-cell lymphoma (HSTCL), a rare aggressive lymphoma that is often fatal, have been identified in patients treated with adalimumab. Most of the patients had prior infliximab therapy as well as concomitant azathioprine or 6-mercaptopurine use for Crohn's disease. The potential risk with the combination of azathioprine or 6-mercaptopurine and HYRIMOZ (adalimumab injection) should be carefully considered. The causal association of HSTCL with adalimumab is not clear.

#### **Infections**

Serious infections due to bacterial, mycobacterial, invasive fungal (disseminated or extrapulmonary histoplasmosis, aspergillosis, coccidioidomycosis), viral, parasitic, or other opportunistic infections have been reported in patients receiving tumor necrosis factor (TNF)-blocking agents. Sepsis, rare cases of tuberculosis, candidiasis, listeriosis, legionellosis and pneumocystis have also been reported with the use of TNF-blocking agents, including adalimumab. Other serious infections seen in clinical trials include pneumonia, pyelonephritis, septic arthritis and septicemia. Hospitalization or fatal outcomes associated with infections have been reported. Many of the serious infections have occurred in patients on concomitant immunosuppressive therapy that, in addition to their underlying disease, could predispose them to infections.

Treatment with HYRIMOZ should not be initiated in patients with active infections, including chronic or localized infections, until infections are controlled. In patients who have been exposed to tuberculosis, and patients who have travelled in areas of high risk of tuberculosis or endemic mycoses, such as histoplasmosis, coccidioidomycosis, or blastomycosis, the risk and benefits of treatment with HYRIMOZ should be considered prior to initiating therapy. See (WARNINGS AND PRECAUTIONS, Infections, Other Opportunistic Infections).

As with other TNF-blockers, patients should be monitored closely for infections (including tuberculosis) before, during and after treatment with HYRIMOZ.

Patients who develop a new infection while undergoing treatment with HYRIMOZ should be monitored closely and undergo a complete diagnostic evaluation. Administration of HYRIMOZ should be discontinued if a patient develops a serious infection or sepsis, and appropriate antimicrobial or antifungal therapy should be initiated.

Physicians should exercise caution when considering the use of HYRIMOZ in patients with a history of recurrent infection or with underlying conditions which may predispose them to infections, or patients who have resided in regions where tuberculosis and histoplasmosis are endemic. See (WARNINGS AND PRECAUTIONS, Infections, Tuberculosis) and (ADVERSE REACTIONS, Adverse Drug Reaction Overview, Infections). The benefits and risks of treatment with HYRIMOZ should be carefully considered before initiating therapy.

#### **Pediatric Malignancy**

Lymphoma and other malignancies, some fatal, have been reported in children and adolescent patients treated with TNF-blockers, including adalimumab. See (WARNINGS AND PRECAUTIONS, Malignancies, Malignancies in Pediatric Patients and Young Adults).

## **4 DOSAGE AND ADMINISTRATION**

If an alternate dose is required, other adalimumab products offering such an option should be used.

### **4.1 Dosing Considerations**

To help ensure the traceability of biologic products, including biosimilars, health professionals should recognise the importance of recording both the brand name and the non-proprietary (active ingredient) name as well as other product-specific identifiers such as the Drug Identification Number (DIN) and the batch/lot number of the product supplied.

#### **Pediatrics**

##### **Polyarticular JIA**

See **DOSAGE AND ADMINISTRATION, Recommended Dosage and Dosage Adjustment, Pediatrics, Polyarticular Juvenile Idiopathic Arthritis.**

Safety and effectiveness in pediatric patients with polyarticular JIA less than 2 years of age or in patients with a weight below 10 kg have not been established.

#### **Geriatrics**

Evidence from clinical studies and experience suggests that use of adalimumab in the geriatric population is not associated with differences in effectiveness. No dose adjustment is needed for this population. A brief discussion can be found under (**WARNINGS AND PRECAUTIONS, Special Populations, Geriatrics.**)

### Gender

No gender-related pharmacokinetic differences were observed after correction for a patient's body weight. Healthy volunteers and patients with rheumatoid arthritis displayed similar adalimumab pharmacokinetics.

### Race

No differences in immunoglobulin clearance would be expected among races. From limited data in non-Caucasians, no important kinetic differences were observed for adalimumab. Dosage adjustment is not required.

### Hepatic Insufficiency

No pharmacokinetic data are available in patients with hepatic impairment. No dose recommendation can be made.

### Renal Insufficiency

No pharmacokinetic data are available in patients with renal impairment. No dose recommendation can be made.

### Disease States

Healthy volunteers and patients with rheumatoid arthritis displayed similar adalimumab pharmacokinetics. See (**ACTION AND CLINICAL PHARMACOLOGY, Special Populations and Conditions, Disease States**).

### Concomitant Medications

Methotrexate, glucocorticoids, salicylates, nonsteroidal anti-inflammatory drugs (NSAIDs), analgesics or other DMARDs may be continued during treatment with HYRIMOZ. When treated with HYRIMOZ as monotherapy, some rheumatoid arthritis patients who experience a decrease in their response to HYRIMOZ 40 mg every other week may benefit from an increase in dose intensity to HYRIMOZ 40 mg every week.

## 4.2 Recommended Dose and Dosage Adjustment

### Pediatrics

#### Polyarticular Juvenile Idiopathic Arthritis

The recommended dose of HYRIMOZ for patients with polyarticular JIA from 2 years of age is based on body weight (**Table 1**). HYRIMOZ is administered every other week via subcutaneous injection. HYRIMOZ can be used in combination with methotrexate or as monotherapy in case of intolerance to methotrexate or when continued treatment with methotrexate is not appropriate.

**Table 1. HYRIMOZ Dose for Patients with Polyarticular JIA**

Safety and effectiveness in pediatric patients with polyarticular JIA less than 2 years of age or in patients with a weight below 10 kg have not been established.

Patient Weight	Dosing Regimen
10 kg to < 30 kg*	20 mg every other week



≥ 30 kg	40 mg every other week
*A dose of 10 mg every other week can be considered for patients weighing 10 to <15 kg. A different adalimumab product should be considered as there are no available presentations of HYRIMOZ capable of delivering 10 mg.	

Available data suggest that clinical response is usually achieved within 12 weeks of treatment. Efficacy and safety in patients who do not respond by Week 16 have not been established.

There is no relevant use of adalimumab in children aged <2 years in this indication.

## Adults

### Rheumatoid Arthritis

The recommended dose of HYRIMOZ for adult patients with rheumatoid arthritis is 40 mg administered every other week as a subcutaneous injection.

### Psoriatic Arthritis

The recommended dose of HYRIMOZ for adult patients with psoriatic arthritis is 40 mg administered every other week as a subcutaneous injection.

For the rheumatoid arthritis and psoriatic arthritis indications, available data suggest that the clinical response is usually achieved within 12 weeks of treatment. Continued therapy should be carefully reconsidered in a patient not responding within this time period.

### Ankylosing Spondylitis

The recommended dose of HYRIMOZ for patients with ankylosing spondylitis is HYRIMOZ 40 mg administered every other week via subcutaneous injection. Glucocorticoids, salicylates, nonsteroidal anti-inflammatory drugs, analgesics or disease modifying anti-rheumatic drugs can be continued during treatment with HYRIMOZ.

### Crohn's Disease

The recommended HYRIMOZ induction dose regimen for adult patients with Crohn's disease is 160 mg at Week 0, followed by 80 mg at Week 2 administered by subcutaneous injection. The first dose of 160 mg can be given in one day (four 40 mg injections or two 80 mg injections) or split over two consecutive days (two 40 mg injections or one 80 mg injection each day). The second dose of 80 mg at Week 2 is given as two 40 mg injections or one 80 mg injection in one day.

The recommended HYRIMOZ maintenance dose regimen for adult patients with Crohn's disease is 40 mg every other week beginning at Week 4.

During treatment with HYRIMOZ, other concomitant therapies (e.g., corticosteroids and/or immunomodulatory agents) should be optimized.

For patients who experience a disease flare, dose escalation may be considered. See **(CLINICAL TRIALS)**.

Some patients who have not responded by Week 4 (induction period) may benefit from continued maintenance therapy through Week 12. Available data suggest that the clinical response is usually achieved at Week 4 of treatment. Continued therapy should be carefully reconsidered in a patient not responding within this time period.

The use of adalimumab in Crohn's disease has been evaluated up to one year in controlled clinical studies. In open-label studies, 510/1,594 patients were evaluated for three years, and 118/1,594 patients for at least five years.

### Ulcerative Colitis

The recommended HYRIMOZ induction dose regimen for adult patients with ulcerative colitis is 160 mg at Week 0, followed by 80 mg at Week 2 administered by subcutaneous injection. The first dose of 160 mg can be given in one day (four 40 mg injections or two 80 mg injections) or split over two consecutive days (two 40 mg injections or one 80 mg injection each day). The second dose of 80 mg at Week 2 is given as two 40 mg injections or one 80 mg injection in one day. Beginning at Week 4, continue with a dose of 40 mg every other week. Adalimumab should only be continued in patients who have responded during the first 8 weeks of therapy.

Aminosalicylates and/or corticosteroids may be continued during treatment with HYRIMOZ. Azathioprine and 6-mercaptopurine (6-MP) may be continued during treatment with HYRIMOZ if necessary (see **WARNINGS AND PRECAUTIONS, Serious Warnings and Precautions**).

During maintenance treatment, corticosteroids may be tapered in accordance with clinical practice guidelines.

### Hidradenitis Suppurativa

The recommended HYRIMOZ initial dose for adult patients with hidradenitis suppurativa is 160 mg, followed by 80 mg two weeks later administered by subcutaneous injection. The first dose of 160 mg at Week 0 can be given in one day (four 40 mg injections or two 80 mg injections) or split over two consecutive days (two 40 mg injections or one 80 mg injection each day). The second dose of 80 mg at Week 2 is given as two 40 mg injections or one 80 mg injection in one day.

The recommended HYRIMOZ maintenance dose regimen for adult patients with hidradenitis suppurativa is 40 mg every week beginning four weeks after the initial dose. Antibiotics may be continued during treatment with HYRIMOZ if necessary.

In patients without any benefit after 12 weeks of treatment, continued therapy should be reconsidered.

### Plaque Psoriasis

The recommended dose of HYRIMOZ for adult patients with psoriasis is an initial dose of 80 mg administered subcutaneously (two 40 mg injections or one 80 mg injection), followed by 40 mg subcutaneously given every other week starting one week after the initial dose.

Continued therapy beyond 16 weeks should be carefully reconsidered in a patient not responding within this time period.

### Uveitis

The recommended dose of HYRIMOZ for adult patients with non-infectious uveitis is an initial dose of 80 mg administered subcutaneously (two 40 mg injections or one 80 mg injection), followed by 40 mg subcutaneously given every other week starting one week after the initial dose.

HYRIMOZ can be initiated in combination with corticosteroids and/or other non-biologic immunomodulatory agents. Corticosteroids may be tapered in accordance with clinical practice starting two weeks after initiating treatment with HYRIMOZ. There is limited experience with the initiation of treatment with adalimumab alone.

It is recommended that the benefit and risk of continued long-term treatment should be evaluated on a yearly basis.

### **4.3 Administration**

HYRIMOZ is intended for use under the guidance and supervision of a physician. Patients may self-inject HYRIMOZ if their physician determines that it is appropriate and with medical follow-up, as necessary, after proper training in subcutaneous injection technique.

#### **Pre-filled Syringe or Pre-filled Pen**

The solution in the pre-filled pen or pre-filled syringe should be carefully inspected visually for particulate matter and discoloration prior to subcutaneous administration. If particulates and discolorations are noted, the product should not be used. HYRIMOZ does not contain preservatives; therefore, unused portions of drug remaining in the syringe should be discarded.

The HYRIMOZ single-dose pre-filled Sensoready® Pen and the single-dose pre-filled syringe with BD UltraSafe Passive™ Needle Guard are available with a 29 gauge ½ inch needle and a removable needle cap.

Patients using the pre-filled syringes should be instructed to inject the full amount in the syringe, according to the directions provided in the PATIENT MEDICATION INFORMATION.

Injection sites should be rotated and injections should never be given into areas where the skin is tender, bruised, scaly, red or hard. See (**PATIENT MEDICATION INFORMATION**).

### **4.4 Missed Dose**

Patients who miss a dose of HYRIMOZ should be advised to inject this missed dose as soon as they become aware of it, and then follow with their next scheduled dose.

## 5 OVERDOSAGE

For management of a suspected drug overdose, contact your regional poison control centre immediately.

The maximum tolerated dose of adalimumab has not been established in humans. Multiple doses up to 10 mg/kg have been administered to patients in clinical trials without evidence of dose-limiting toxicities. In case of overdose, it is recommended that the patient be monitored for any signs or symptoms of adverse reactions or effects and appropriate symptomatic treatment instituted immediately.

## 6 DOSAGE FORMS, STRENGTHS, COMPOSITION AND PACKAGING

Route of Administration	Dose Form/Strength/Composition	Non-medicinal Ingredients
Subcutaneous Injection	Sterile solution for injection/ 20 mg/0.4 mL (50 mg/mL) pre-filled syringe 40 mg/0.8 mL (50 mg/mL) pre-filled pen and 40 mg/0.8 mL (50 mg/mL) pre-filled syringe	adipic acid, citric acid monohydrate, sodium chloride, mannitol, polysorbate 80 and water for injection. Hydrochloric acid and sodium hydroxide are added as necessary to adjust pH

HYRIMOZ (adalimumab injection) is supplied as a sterile solution for subcutaneous administration in the following packaging configurations:

### Single-dose pre-filled HYRIMOZ SensoReady® Pen

Injection: 40 mg/0.8 mL of HYRIMOZ is provided by a single-dose pen (SensoReady® Pen), containing a 1 mL pre-filled glass syringe with a fixed 29-gauge, ½-inch needle and a black needle cover

### Single-dose pre-filled syringe with BD UltraSafe Passive™ Needle Guard

Injection: 20 mg/0.4 mL of HYRIMOZ is provided by a single-dose, 1 mL pre-filled glass syringe with a needle guard and add-on finger flange, a fixed 29-gauge, ½-inch needle and a needle cover.

Injection: 40 mg/0.8 mL of HYRIMOZ is provided by a single-dose, 1 mL pre-filled glass syringe with a needle guard and add-on finger flange, a fixed 29-gauge, ½-inch needle and a needle cover.

HYRIMOZ (adalimumab) is supplied as a preservative-free, sterile solution for subcutaneous administration. The following packaging configurations are available.

### HYRIMOZ single-dose pre-filled syringe – 20 mg/0.4 mL (2 count)

HYRIMOZ is dispensed in a carton containing 2 blister packages. Each blister package consists of a single-dose, 1 mL pre-filled glass syringe with a fixed 29-gauge, ½ inch needle, providing 20 mg/0.4 mL of HYRIMOZ.

### HYRIMOZ single-dose pre-filled syringe – 40 mg/0.8 mL (2 count)

HYRIMOZ is dispensed in a carton containing 2 blister packages. Each blister package consists of a single-dose, 1 mL pre-filled glass syringe with a fixed 29-gauge, ½ inch needle, providing 40 mg/0.8 mL of HYRIMOZ.

#### **HYRIMOZ single-dose pre-filled SensoReady® Pen – 40 mg/0.8 mL (2 count)**

HYRIMOZ is dispensed in a carton containing 2 single-dose pre-filled SensoReady® Pens. Each Pen consists of a single-dose, 1 mL pre-filled glass syringe with a fixed 29-gauge, ½ inch needle, providing 40 mg/0.8 mL of HYRIMOZ.

## **7 DESCRIPTION**

HYRIMOZ (adalimumab injection) is a recombinant human immunoglobulin (IgG1) monoclonal antibody. Adalimumab was created using phage display technology resulting in fully human heavy and light chain variable regions, which confer specificity to human tumor necrosis factor (TNF), and human IgG1 heavy chain and kappa light chain sequences. Adalimumab binds with high affinity and specificity to soluble tumor necrosis factor (TNF-alpha) but not lymphotoxin (TNF-beta). Adalimumab is produced by recombinant DNA technology in a mammalian cell expression system. It consists of 1,330 amino acids and has a molecular weight of approximately 148 kilodaltons.

## **8 WARNINGS AND PRECAUTIONS**

Please see the **Serious Warnings and Precautions Box** at the beginning of Part I: Health Professional Information.

### **General**

#### **Concurrent Administration of Biologic DMARDs or TNF-Antagonists**

Serious infections were seen in clinical studies with concurrent use of anakinra (an interleukin-1 antagonist) and another TNF-blocking agent, etanercept, with no added benefit compared to etanercept alone. Because of the nature of the adverse events seen with the combination of etanercept and anakinra, similar toxicities may also result from the combination of anakinra and other TNF-blocking agents. Therefore, the combination of HYRIMOZ (adalimumab injection) and anakinra is not recommended. See (**DRUG INTERACTIONS, Drug-Drug Interactions**).

Concomitant administration of HYRIMOZ with other biologic DMARDs (e.g., anakinra and abatacept) or other TNF antagonists is not recommended based upon the increased risk for infections and other potential pharmacological interactions. See (**DRUG INTERACTIONS, Drug-Drug Interactions** ).

#### **Switching Between Biological DMARDs**

When switching from one biologic to another, patients should continue to be monitored for signs of infection.

#### **Surgery**

There is limited safety experience of surgical procedures in patients treated with adalimumab.

The long half-life of adalimumab should be taken into consideration if a surgical procedure is planned. A patient who requires surgery while on HYRIMOZ should be closely monitored for infections, and appropriate actions should be taken. There is limited safety experience in patients undergoing arthroplasty while receiving adalimumab.

### **Carcinogenesis and Mutagenesis**

Long-term animal studies of adalimumab have not been conducted to evaluate the carcinogenic potential or its effect on fertility. No clastogenic or mutagenic effects of adalimumab were observed in the in vivo mouse micronucleus test or the Salmonella-Escherichia coli (Ames) assay, respectively. See (**TOXICOLOGY, Mutagenicity and Carcinogenicity, In vitro Genotoxicity**).

### **Cardiovascular**

#### **Patients with Congestive Heart Failure**

Cases of worsening congestive heart failure (CHF) and new onset CHF have been reported with TNF-blockers. Cases of worsening CHF have also been observed with adalimumab. Adalimumab has not been formally studied in patients with CHF; however, in clinical trials of another TNF-blocker, a higher rate of serious CHF-related adverse events was observed. Physicians should exercise caution when using HYRIMOZ in patients who have heart failure and monitor them carefully. HYRIMOZ is contraindicated in moderate to severe heart failure (see **CONTRAINDICATIONS**).

### **Gastrointestinal**

#### **Small Bowel Obstruction**

Failure to respond to treatment for Crohn's disease may indicate the presence of fixed fibrotic stricture that may require surgical treatment. Available data suggest that adalimumab does not worsen or cause strictures.

### **Hematologic Events**

Rare reports of pancytopenia, including aplastic anemia, have been reported with TNF-blocking agents. Adverse events of the hematologic system, including medically significant cytopenia (e.g., thrombocytopenia, leukopenia) have been infrequently reported with adalimumab. The causal relationship of these reports to adalimumab remains unclear. All patients should be advised to seek immediate medical attention if they develop signs and symptoms suggestive of blood dyscrasias (e.g., persistent fever, bruising, bleeding, pallor) while on HYRIMOZ. Discontinuation of HYRIMOZ therapy should be considered in patients with confirmed significant hematologic abnormalities.

### **Hypersensitivity Reactions**

Allergic reactions (e.g., allergic rash, anaphylactoid reaction, fixed drug reaction, non-specified drug reaction, urticaria) have been observed in approximately 1% of patients receiving

adalimumab in clinical trials. See (ADVERSE REACTIONS). Reports of serious allergic reactions, including anaphylaxis, have been received following adalimumab administration. If an anaphylactic reaction or other serious allergic reactions occur, administration of HYRIMOZ should be discontinued immediately and appropriate therapy initiated.

## **Immune**

### **Autoimmunity**

Treatment with adalimumab may result in the formation of autoantibodies and rarely, in the development of a lupus-like syndrome. If a patient develops symptoms suggestive of a lupus-like syndrome following treatment with HYRIMOZ, treatment should be discontinued. See (ADVERSE REACTIONS, **Adverse Drug Reaction Overview**, **Autoantibodies**).

### **Immunosuppression**

The possibility exists for TNF-blocking agents, including adalimumab, to affect host defences against infections and malignancies since TNF mediates inflammation and modulates cellular immune responses. In a study of 64 patients with rheumatoid arthritis who were treated with adalimumab, there was no evidence of depression of delayed-type hypersensitivity, depression of immunoglobulin levels, or change in enumeration of effector T- and B-cells and NK-cells, monocyte/macrophages, and neutrophils. The impact of treatment with adalimumab on the development and course of malignancies, as well as active and/or chronic infections, is not fully understood. See (WARNINGS AND PRECAUTIONS, **Infections** and **Malignancies**) and (ADVERSE REACTIONS, **Adverse Drug Reaction Overview**, **Infections** and **Malignancies**).

### **Immunizations**

In a randomized, double-blind, placebo-controlled study in 226 adult rheumatoid arthritis patients treated with adalimumab, antibody responses to concomitant pneumococcal and influenza vaccines were assessed. Protective antibody levels to the pneumococcal antigens were achieved by 86% of patients in the adalimumab group compared to 82% in the placebo group. A total of 37% of adalimumab-treated patients and 40% of placebo-treated patients achieved at least a 2-fold increase in antibody titer to at least three out of five pneumococcal antigens. In the same study, 98% of patients in the adalimumab group and 95% in the placebo group achieved protective antibody levels to the influenza antigens. A total of 52% of adalimumab-treated patients and 63% of placebo-treated patients achieved at least a 4-fold increase in antibody titer to at least two out of three influenza antigens.

It is recommended that pediatric patients, if possible, be brought up to date with all immunizations in agreement with current immunization guidelines prior to initiating HYRIMOZ therapy.

Patients on HYRIMOZ may receive concurrent vaccinations, except for live vaccines. No data are available on the secondary transmission of infection by live vaccines in patients receiving adalimumab.

Administration of live vaccines to infants exposed to adalimumab in utero is not recommended

for five months following the mother's last HYRIMOZ injection during pregnancy. See (**WARNINGS AND PRECAUTIONS, Special Populations, Pregnant Women**).

## **Infections**

### **Tuberculosis**

Tuberculosis, including reactivation and new onset of tuberculosis, has been reported in patients receiving adalimumab. Reports included cases of pulmonary and extrapulmonary (i.e., disseminated) tuberculosis. Before initiation, during and after treatment with HYRIMOZ, patients should be evaluated for active and inactive ("latent") tuberculosis infection with a tuberculin skin test. Treatment of latent tuberculosis infections should be initiated prior to therapy with HYRIMOZ. When tuberculin skin testing is performed for latent tuberculosis infection, an induration size of 5 mm or greater should be considered positive, even if vaccinated previously with Bacille Calmette-Guérin (BCG).

If active tuberculosis is diagnosed, HYRIMOZ therapy must not be initiated.

The possibility of undetected latent tuberculosis should be considered, especially in patients who have immigrated from or traveled to countries with a high prevalence of tuberculosis or who had close contact with a person with active tuberculosis. If latent infection is diagnosed, appropriate treatment must be started with anti-tuberculosis prophylactic treatment, in accordance with the Canadian Tuberculosis Standards and Centers for Disease Control and Prevention guidelines, before the initiation of HYRIMOZ. Use of anti-tuberculosis prophylactic treatment should also be considered before the initiation of HYRIMOZ in patients with several or significant risk factors for tuberculosis despite a negative test for tuberculosis and in patients with a past history of latent or active tuberculosis in whom an adequate course of treatment cannot be confirmed. The decision to initiate anti-tuberculosis therapy in these patients should only be made after taking into account both the risk for latent tuberculosis infection and the risks of anti-tuberculosis therapy. If necessary, consultation should occur with a physician with expertise in the treatment of tuberculosis.

Despite prophylactic treatment for tuberculosis, cases of reactivated tuberculosis have occurred in patients receiving adalimumab. Also, active tuberculosis has developed in patients receiving adalimumab whose screening for latent tuberculosis infection was negative, and some patients who have been successfully treated for active tuberculosis have redeveloped active tuberculosis while being treated with TNF-blocking agents.

Patients receiving HYRIMOZ should be monitored for signs and symptoms of active tuberculosis, particularly because tests for latent tuberculosis infection may be falsely negative. The risk of false negative tuberculin skin test results should be considered, especially in patients who are severely ill or immunocompromised. Patients should be instructed to seek medical advice if signs/symptoms suggestive of a tuberculosis infection (e.g., persistent cough, wasting/weight loss, low grade fever, listlessness) occur during or after therapy with HYRIMOZ, and physicians should monitor for signs and symptoms of active tuberculosis, including patients who are tuberculosis skin test negative.

### **Other Opportunistic Infections**



Opportunistic infections, including invasive fungal infections, have been observed in patients receiving adalimumab. These infections are not consistently recognized in patients taking TNF-blockers and this has resulted in delays in appropriate treatment, sometimes resulting in fatal outcomes.

Patients taking TNF-blockers are more susceptible to serious fungal infections such as histoplasmosis, coccidioidomycosis, blastomycosis, aspergillosis, candidiasis, and other opportunistic infections. Those who develop fever, malaise, weight loss, sweats, cough, dyspnea, and/or pulmonary infiltrates, or other serious systemic illness with or without concomitant shock should promptly seek medical attention for a diagnostic evaluation.

For patients who reside or travel in regions where mycoses are endemic, invasive fungal infections should be suspected if they develop the signs and symptoms of possible systemic fungal infection. Patients are at risk of histoplasmosis and other invasive fungal infections and hence clinicians should consider empiric antifungal treatment until the pathogen(s) are identified. Antigen and antibody testing for histoplasmosis may be negative in some patients with active infection. When feasible, the decision to administer empiric antifungal therapy in these patients should be made in consultation with a physician with expertise in the diagnosis and treatment of invasive fungal infections and should take into account both the risk for severe fungal infection and the risks of antifungal therapy. Patients who develop a severe fungal infection are also advised to stop the TNF-blocker until infections are controlled.

### **Hepatitis B Virus (HBV) Reactivation**

Very rare cases of hepatitis B virus (HBV) reactivation have been associated with anti-TNF therapy. Clinically active HBV infection occurred following a latency period ranging from 3 to 20 months after initiation of therapy. In the majority of cases, patients were also taking other immunosuppressive drugs, including methotrexate, azathioprine, and/or corticosteroids. Hence, establishing a causal relationship to anti-TNF agents is confounded by the presence of these other medications. Where outcome information was provided, most patients were reported to have improved after antiviral treatment and/or discontinuation of the anti-TNF agent. However, fatal outcomes have also occurred in reported cases. Patients at risk of HBV infection should be evaluated for prior evidence of HBV infection before initiating anti-TNF therapy. Those identified as chronic carriers (i.e., surface antigen positive) should be monitored for signs and symptoms of active HBV infection throughout the course of therapy and for several months following discontinuation of therapy. Reactivation of HBV is not unique to anti-TNF-alpha agents and has been reported with other immunosuppressive drugs.

### **Malignancies**

In the controlled portions of clinical trials of some TNF-blocking agents, including adalimumab, more cases of malignancies have been observed among patients receiving those TNF-blockers compared to control patients.

In the controlled and uncontrolled open-label portions of clinical trials of adalimumab, the more frequently observed malignancies, other than lymphoma and non-melanoma skin cancer, were breast, colon, prostate, lung, and melanoma.

Cases of acute and chronic leukemia have been reported in association with post-marketing TNF-blocker use in rheumatoid arthritis and other indications. Patients with rheumatoid arthritis may be at a higher risk (up to 2-fold) than the general population for the development of leukemia, even in the absence of TNF-blocking therapy.

### **Malignancies in Pediatric Patients and Young Adults**

Malignancies, some fatal, have been reported among children, adolescents and young adults who received treatment with TNF-blocking agents (i.e., including adalimumab). Approximately half the cases were lymphomas, including Hodgkin's and non-Hodgkin's lymphoma. The other cases represented a variety of different malignancies and included rare malignancies usually associated with immunosuppression and malignancies that are not usually observed in children and adolescents. The malignancies occurred after a median of 30 months of therapy (range 1 to 84 months). Most of the patients were receiving concomitant immunosuppressants. These cases were reported post-marketing and are derived from a variety of sources including registries and spontaneous post-marketing reports.

Post-marketing cases of hepatosplenic T-cell lymphoma (HSTCL), a rare type of T-cell lymphoma, have been reported in patients treated with TNF-blockers including adalimumab. These cases have had a very aggressive disease course and have been fatal. The majority of reported TNF-blocker cases have occurred in patients with Crohn's disease or ulcerative colitis and the majority were in adolescent and young adult males. Almost all of these patients had received treatment with the immunosuppressants azathioprine or 6-mercaptopurine (6-MP) concomitantly with a TNF-blocker at or prior to diagnosis. It is uncertain whether the occurrence of HSTCL is related to use of a TNF-blocker or a TNF-blocker in combination with these other immunosuppressants. The potential risk with the combination of azathioprine or 6-mercaptopurine and HYRIMOZ should be carefully considered.

No malignancies were observed in the indicated pediatric patient population with Crohn's disease treated with adalimumab (n=102) for 52 weeks in a clinical trial.

Treatment-emergent malignancies occurred in 2/480 adalimumab-treated UC patients in the double-blind controlled portion of two clinical trials (range of treatment duration from Weeks 0 to 52). The malignancies were squamous cell carcinoma and gastric cancer. Gastric cancer was considered serious and the patient discontinued as a result.

With current data it is not known if adalimumab treatment influences the risk for developing dysplasia or colon cancer. All patients with ulcerative colitis who are at risk for dysplasia or colon carcinoma (for example, patients with long-standing ulcerative colitis or primary sclerosing cholangitis), or who had a prior history of dysplasia or colon carcinoma should be screened for dysplasia at regular intervals before therapy and throughout their disease course. This evaluation should include colonoscopy and biopsies per local recommendations.

### **Lymphoma**

In the controlled portions of clinical trials of all the TNF-blocking agents, more cases of lymphoma have been observed among patients receiving TNF-blockers compared to control

patients.

However, for adalimumab, the occurrence of lymphoma was rare, and the follow-up period of placebo patients was shorter than for patients receiving TNF-antagonist therapy. The size of the control group and limited duration of the controlled portions of studies precludes the ability to draw firm conclusions. Furthermore, there is an increased background lymphoma risk in rheumatoid arthritis patients with long-standing, highly active, inflammatory disease, which complicates the risk estimation.

In combining the controlled and uncontrolled open-label portions of the 23 clinical trials in adult patients with rheumatoid arthritis, psoriatic arthritis, ankylosing spondylitis, Crohn's disease, ulcerative colitis, hidradenitis suppurativa, psoriasis, and uveitis, with a median duration of approximately 2.4 years, including 8764 patients and 27,196 patient-years of therapy, the observed rate of lymphomas (95% CI) is 1.2 [0.9, 1.7] per 1000 patient-years. This is approximately 3-fold higher than expected in the general population.

During the controlled and open-label periods of 14 trials with adalimumab, the overall standard incidence ratio (SIR) of malignancies was 0.99 [95% confidence interval (CI), 0.81 to 1.20]. With current knowledge in this area, a possible risk for development of lymphomas or other malignancies in patients treated with a TNF-antagonist cannot be excluded.

No studies have been conducted that include patients with a history of malignancy or that continue treatment in patients who develop malignancy while receiving adalimumab. Additional caution should be exercised when considering HYRIMOZ treatment in these patients.

### **Non-Lymphoma Malignancy**

During the controlled portions of 21 adalimumab trials in adult patients with rheumatoid arthritis, psoriatic arthritis, ankylosing spondylitis, Crohn's disease, ulcerative colitis, hidradenitis suppurativa, psoriasis, and uveitis, malignancies, other than lymphoma and non-melanoma skin cancer, were observed at a rate (95% CI) of 6.9 (4.4, 10.6) per 1,000 patient-years among 5196 adalimumab-treated patients versus a rate of 6.4 (3.5, 11.9) per 1,000 patient-years among 3347 control patients (median duration of treatment of 4.0 months for adalimumab-treated patients and 3.9 months for control-treated patients).

During the controlled portions of 21 adalimumab rheumatoid arthritis, psoriatic arthritis, ankylosing spondylitis, Crohn's disease, ulcerative colitis, hidradenitis suppurativa, psoriasis, and uveitis trials, the rate (95% CI) of non-melanoma skin cancers was 8.9 (6.1, 13.1) per 1,000 patient-years among adalimumab-treated patients and 3.2 (1.3, 7.7) per 1,000 patient-years among control patients. Of these skin cancers, squamous cell carcinomas occurred at rates (95% CI) of 2.7 (1.4, 5.5) per 1,000 patient-years among adalimumab-treated patients and 0.6 (0.1, 4.6) per 1,000 patient-years among control patients. The rate (95% CI) of lymphomas was 0.7 (0.2, 2.7) per 1,000 patient-years among adalimumab-treated patients and 0.6 (0.1, 4.6) per 1,000 patient-years among control patients.

The observed rate of malignancies, other than lymphoma and non-melanoma skin cancers, is approximately (95% CI) 8.5 (7.4, 9.7) per 1,000 patient years in the controlled portion of clinical trials and in ongoing and completed open-label extension studies. The observed rate of non-melanoma skin cancers is (95% CI) approximately 9.6 (8.5, 10.9) per 1,000 patient years, and

the observed rate of lymphomas is (95% CI) approximately 1.3 (0.9, 1.8) per 1,000 patient years. The median duration of these studies is approximately 3.3 years and included 6276 adult patients who were on adalimumab for at least one year or who developed a malignancy within a year of starting therapy, representing over 26,044 patient years of therapy.

All patients, and in particular psoriasis patients with a medical history of extensive immunosuppressant therapy or psoriasis patients with a history of Psoralen Ultra-Violet A (PUVA) treatment should be examined for the presence of non-melanoma skin cancer prior to and during treatment with HYRIMOZ.

## **Neurologic Events**

Use of TNF-blocking agents, including adalimumab, has been associated with rare cases of new onset or exacerbation of clinical symptoms and/or radiographic evidence of demyelinating disease, including multiple sclerosis, and optic neuritis, and peripheral demyelinating disease, including Guillain-Barré syndrome. Prescribers should exercise caution in considering the use of HYRIMOZ in patients with pre-existing or recent onset central nervous system demyelinating disorders; discontinuation of HYRIMOZ should be considered if any of these disorders develop.

There is a known association between intermediate uveitis and central demyelinating disorders. Neurologic evaluation should be performed in patients with non-infectious intermediate uveitis prior to the initiation of adalimumab therapy to assess for pre-existing central demyelinating disorders.

### **8.1 Special Populations**

#### **8.1.1 Pregnant Women**

The extent of exposure in pregnancy during clinical trials is very limited, consisting only of individual cases.

An embryo-fetal perinatal developmental toxicity study has been performed in cynomolgus monkeys at dosages up to 100 mg/kg (266 times human area under the curve (AUC) when given 40 mg adalimumab subcutaneously with methotrexate every week, or 373 times human AUC when given 40 mg adalimumab subcutaneously without methotrexate) and has revealed no evidence of harm to the fetuses due to adalimumab. There are, however, no adequate and well-controlled studies in pregnant women. Because animal reproduction and developmental studies are not always predictive of human response, HYRIMOZ should be used during pregnancy only if clearly needed.

In a prospective cohort pregnancy exposure registry, conducted by the Organization of Teratology Information Specialists (OTIS)/MotherToBaby in the U.S. and Canada between 2004 and 2016, the risk of major birth defects in live-born infants was compared in 69 women with RA and 152 women with CD treated with adalimumab at least during the first trimester with 74 women with RA and 32 women with CD not treated with adalimumab during pregnancy. The proportion of major birth defects among live-born infants in the adalimumab-treated and untreated cohorts was 10% (8.7% RA, 10.5% CD) and 7.5% (6.8% RA, 9.4% CD), respectively.

No pattern of major birth defects was observed. This study cannot reliably establish whether

there is an association between adalimumab and the risk for major birth defects because of methodological limitations of the registry, including small sample size, the voluntary nature of the study, and the non-randomized design.

Adalimumab may cross the placenta into the serum of infants born to women treated with HYRIMOZ during pregnancy. Consequently, these infants may be at increased risk for infection. Administration of live vaccines to infants exposed to adalimumab in utero is not recommended for five months following the mother's last HYRIMOZ injection during pregnancy.

## **Labor and Delivery**

There are no known effects of adalimumab on labor or delivery.

### **8.1.2 Nursing Women**

Limited Information from case reports in the published literature indicates the presence of adalimumab in human milk at concentrations of 0.1% to 1% of the maternal serum level. Published data suggest that the systemic exposure of adalimumab to a breastfed infant is expected to be low because adalimumab is a large molecule and is degraded in the gastrointestinal tract. However, the effects of local exposure in the gastrointestinal tract are unknown. The developmental and health benefits of breastfeeding should be considered along with the mother's clinical need for adalimumab and any potential adverse effects on the breastfed child from adalimumab or from the underlying maternal condition.

### **8.1.3 Pediatrics**

#### **Polyarticular JIA**

The efficacy and safety of adalimumab have been studied in pediatric patients aged 4 to 17 years (n=171) and 2 to 4 years (n=32). No overall differences were observed in the efficacy and safety between the two age groups. Adalimumab has not been studied in pediatric patients with polyarticular JIA less than 2 years of age or in pediatric patients with a weight below 10 kg.

### **8.1.4 Geriatrics (>65 years of age)**

A total of 519 rheumatoid arthritis patients 65 years of age and older, including 107 patients 75 years and older, received adalimumab in clinical Studies DE009, DE011, DE019 and DE031. No overall differences in effectiveness were observed between these patients and younger patients. The frequency of serious infection and malignancy among adalimumab-treated patients over age 65 was higher than for those under the age of 65. Because there is a higher incidence of infections and malignancies in the elderly population in general, caution should be used when treating the elderly.

### **Monitoring and Laboratory Tests**

There is no known interference between adalimumab and laboratory tests.

## 9 ADVERSE REACTIONS

The adverse drug reaction profiles reported in clinical studies that compared HYRIMOZ (adalimumab injection) to the reference biologic drug were comparable. The description of adverse reactions in this section is based on clinical experience with the reference biologic drug.

### 9.1 Adverse Reaction Overview

The most serious adverse reactions were [see (WARNINGS AND PRECAUTIONS)]:

- serious infections
- neurologic events
- malignancies

The most common adverse reaction in rheumatoid arthritis patients treated with adalimumab was injection site reactions. In controlled trials for rheumatoid arthritis, polyarticular JIA, psoriatic arthritis, ankylosing spondylitis, adult Crohn's disease, ulcerative colitis, adult hidradenitis suppurativa, psoriasis, and adult uveitis, 13% of patients treated with adalimumab developed injection site reactions (erythema and/or itching, hemorrhage, pain or swelling), compared to 7% of patients receiving control treatment. Most injection site reactions were described as mild and generally did not necessitate drug discontinuation.

The proportion of rheumatoid arthritis patients who discontinued treatment due to adverse events during the double-blind, placebo-controlled portion of rheumatoid arthritis Studies DE009, DE011, DE019 and DE031 was 7.0% for patients taking adalimumab, and 4.0% for placebo-treated patients. The most common adverse events leading to discontinuation of adalimumab were clinical flare reaction (0.7%), rash (0.3%) and pneumonia (0.3%).

Among patients with rheumatoid arthritis in placebo-controlled studies, deaths occurred in 8 of 1,380 (0.58%) adalimumab-treated patients compared to 1 of 690 (0.14%) placebo-treated patients. The rate of deaths in both treatment arms is less than expected in the normal population with a standard mortality ratio (SMR) of 0.87 (95% CI, 0.38, 1.72) in the adalimumab group and 0.25 (95% CI, 0.00, 1.37) in the placebo group.

In Study DE019, 553 patients were exposed to at least one dose of adalimumab and 202 patients completed 10 years of study. A total of 24 patients died during the 10-year exposure period to adalimumab (4 during the double-blind phase, 14 during the open-label extension phase and an additional 6 after study drug termination). Among the treatment-emergent deaths, the most common reasons were: 4 sepsis, 3 cancers and 3 respiratory system events. However, the total number of deaths was not higher than that calculated according to age-adjusted Standardized Mortality Rates.

Of the 553 patients, 23.0% discontinued due to an adverse event. The most common adverse events associated with discontinuation of study drug were pneumonia and breast cancer (n = 5 each). Fatigue, pneumonia, cellulitis, and histoplasmosis (n = 3 each) were the most common treatment-related adverse events leading to discontinuation of study drug.

In total, 49% of patients treated with adalimumab experienced a serious adverse event; 15.7%

were considered at least possibly related to study drug. The most common serious adverse events were rheumatoid arthritis disease flare (n = 35, 6.3%), pneumonia (n = 26, 4.7%) and myocardial infarction (n = 10, 1.8%); of these, only pneumonia was considered to be at least possibly related to study drug.

The most frequently reported treatment-emergent adverse events were infections (total n = 448, 81%; serious n = 85, 15.4%) and injection site reactions (n = 115, 20.8%).

Adverse events of special interest among the 553 patients included 35 patients with malignancies other than non-melanoma skin cancer (including 5 cases of lymphoma); and 3 patients with tuberculosis. Serious adverse events of special interest included 5 patients each with pulmonary embolism and diverticulitis; 2 patients with multiple sclerosis; and 1 patient with hypersensitivity reaction.

Adalimumab has also been studied in 542 patients with early rheumatoid arthritis (disease duration less than three years) who were methotrexate naïve (Study DE013). No new safety signals were seen in this patient population compared to the safety profile seen in adalimumab Studies DE009, DE011, DE019 and DE031. In this study, deaths occurred in 5 of 542 (0.92%) adalimumab-treated patients compared to 1 of 257 (0.39%) methotrexate-treated patients. The rate of deaths in both treatment arms is less than expected in the normal population with a standard mortality ratio (SMR) of 0.57 (95% CI, 0.18, 1.32) in the adalimumab group and 0.22 (95% CI, 0.00, 1.23) in the methotrexate group.

Adalimumab has also been studied in 395 patients with psoriatic arthritis in two placebo-controlled studies and in an open-label extension study, in 393 patients with ankylosing spondylitis in two placebo-controlled studies and in over 1,500 patients with Crohn's disease in five placebo-controlled and two open-label extension studies. The safety profile for patients with psoriatic arthritis treated with adalimumab 40 mg every other week was similar to the safety profile seen in patients with rheumatoid arthritis, adalimumab Studies DE009, DE011, DE019, DE031 and DE013. During the controlled period of the psoriatic arthritis studies, no deaths occurred in the adalimumab-treated or placebo-treated patients. During the psoriatic arthritis open-label study, two deaths occurred in 382 patients with 795.7 patient-years of exposure. The rate of deaths is less than expected in the normal population with a standard mortality ratio (SMR) of 0.39 (95% CI, 0.04, 1.43). Among patients enrolled in the psoriasis open-label study, 5 deaths occurred in 1,468 patients with 4,068.6 patient-years of exposure.

Adalimumab has also been studied in 1,010 patients with ulcerative colitis (UC) in two randomized, double-blind, placebo-controlled studies (M06-826, 8 weeks and M06-827, 52 weeks) and an open-label extension study. No new safety signals were seen in the ulcerative colitis patient population. During the controlled period of the ulcerative colitis studies, no deaths occurred in the adalimumab-treated or placebo-treated patients. In the overall adalimumab ulcerative colitis development program of 1,010 patients with 2007.4 patient years of exposure (622 patients were treated for >1 year), 2 treatment-emergent deaths occurred during the long-term open-label extension study (cardio-respiratory arrest and right ventricular failure). There were no new safety signals compared to the known safety profile of adalimumab in the double-blind controlled portion of ulcerative colitis studies.

Adalimumab has also been studied in 727 adult patients with hidradenitis suppurativa (HS) in

three randomized, double-blind, placebo-controlled studies and an open-label extension study. No deaths were reported during the placebo-control periods. In the overall adalimumab hidradenitis suppurativa development program of 727 patients with 635.7 patient years of exposure (281 patients were treated for >1 year), 2 treatment-emergent deaths occurred (cardio respiratory arrest and autoimmune pancreatitis). No new safety signals were seen in the hidradenitis suppurativa adult patient population.

Adalimumab has also been studied in 464 adult patients with uveitis in two randomized, double-masked, placebo-controlled studies (M10-877 and M10-880) and an open-label extension study (M11-327). No new safety signals for adalimumab were identified in the adult uveitis patient population. In the overall adalimumab adult uveitis development program of 464 adalimumab adult patients with 1308.2 patient-years of exposure, 6 treatment-emergent deaths were reported (chronic renal failure, aortic dissection/acute tamponade, B-cell lymphoma, brain abscess, pancreatic carcinoma, and accident). Two deaths occurred during the controlled period of the adult uveitis studies and 4 during the open-label extension study.

### **Autoantibodies**

Patients had serum samples tested for autoantibodies at multiple time points in Studies DE009, DE011, DE019, DE031 and DE013. In those rheumatoid arthritis controlled trials, 11.9% of patients treated with adalimumab and 8.1% of placebo- or active control-treated patients who had negative baseline antinuclear antibody (ANA) titers, developed positive titers at Week 24. Two patients out of 3441 treated with adalimumab developed clinical signs suggestive of new onset lupus-like syndrome. The patients improved following discontinuation of therapy. No patients developed lupus nephritis or central nervous system symptoms. The impact of long-term treatment with adalimumab on the development of autoimmune diseases is unknown.

### **Immunogenicity**

Formation of anti-adalimumab antibodies is associated with increased clearance and reduced efficacy of adalimumab. There is no apparent correlation between the presence of anti-adalimumab antibodies and adverse events.

### **Pediatric**

In clinical trials with adalimumab therapy for polyarticular JIA, the proportion of patients achieving PedACR response was lower in anti-adalimumab antibody (AAA)-positive patients compared with AAA-negative patients.

In patients with polyarticular JIA who were 4 to 17 years (Study DE038), anti-adalimumab antibodies were identified in 27/171 subjects (15.8%) treated with adalimumab. In patients not given concomitant MTX, the incidence was 22/86 (25.6%), compared to 5/85 (5.9%) when adalimumab was used as add-on to MTX. In patients with polyarticular JIA who were 2 to <4 years of age or 4 years of age and older weighing <15 kg (Study M10-444), anti-adalimumab antibodies were identified in 7% (1/15) of patients, and the one patient was receiving concomitant MTX.

### **Adult**

Rheumatoid arthritis patients in Studies DE009, DE011, and DE019 were tested at multiple time



points for antibodies to adalimumab during the 6- to 12-month period. Approximately 5% (58/1062) of adult rheumatoid arthritis patients receiving adalimumab developed low-titer antibodies to adalimumab at least once during treatment, which were neutralizing in vitro. Patients treated with concomitant methotrexate had a lower rate of antibody development than patients on adalimumab monotherapy (1% versus 12%). With monotherapy, patients receiving every other week dosing may develop antibodies more frequently than those receiving weekly dosing. In patients receiving the recommended dosage of 40 mg every other week as monotherapy, the American College of Rheumatology (ACR 20) response was lower among antibody-positive patients than among antibody-negative patients. The long-term immunogenicity of adalimumab is unknown.

In patients with psoriatic arthritis, anti-adalimumab antibodies were identified in 38/376 patients (10%) treated with adalimumab. In patients not given concomitant methotrexate, the incidence was 13.5% (24/178 patients), compared to 7% (14/198 patients) when adalimumab was used as add-on to methotrexate.

In patients with ankylosing spondylitis, anti-adalimumab antibodies were identified in 17/204 patients (8.3%) treated with adalimumab. In patients not given concomitant methotrexate, the incidence was 16/185 (8.6%), compared to 1/19 (5.3%) when adalimumab was used as add-on to methotrexate.

In patients with Crohn's disease, anti-adalimumab antibodies were identified in 2.6% (7/269) of patients receiving adalimumab.

In patients with ulcerative colitis, anti-adalimumab antibodies were identified in 5.0% (19/379) of patients receiving adalimumab. The clinical significance of this is unknown.

In patients with moderate to severe HS, anti-adalimumab antibodies were identified in 10/99 patients (10.1%) treated with adalimumab.

In patients with psoriasis, anti-adalimumab antibodies were identified in 77/920 patients (8.4%) treated with adalimumab monotherapy.

In patients with plaque psoriasis, the rate of antibody development with adalimumab monotherapy was 8%. However, due to the limitation of the assay conditions, antibodies to adalimumab could be detected only when serum adalimumab levels were < 2 mcg/mL. Among these patients whose serum adalimumab levels were < 2 mcg/mL (approximately 40% of total patients studied), the immunogenicity rate was 20.7%. In patients with plaque psoriasis on long-term adalimumab monotherapy who participated in a withdrawal and retreatment study and whose serum adalimumab levels were < 2 mcg/mL (approximately 12% of total patients studied), the immunogenicity rate was 16%; the overall rate of antibody development prior to withdrawal was 1.9%, and 2.3% after retreatment.

In patients with non-infectious uveitis, anti-adalimumab antibodies were identified in 4.8% (12/249) of patients treated with adalimumab. However, due to the limitation of the assay conditions, antibodies to adalimumab could be detected only when serum adalimumab levels were < 2 mcg/mL. Among the patients whose serum adalimumab levels were < 2 mcg/mL (approximately 23% of total patients studied), the immunogenicity rate was 21.1%.

The data reflect the percentage of patients whose test results were considered positive for antibodies to adalimumab in an enzyme-linked immunosorbent assay (ELISA), and are highly dependent on the sensitivity and specificity of the assay. Additionally, the observed incidence of antibody positivity in an assay may be influenced by several factors including sample handling, timing of sample collection, concomitant medications, and underlying disease. For these reasons, comparison of the incidence of antibodies to adalimumab with the incidence of antibodies to other products may be misleading.

## **Infections**

### Adults

In 23 controlled trials for rheumatoid arthritis, psoriatic arthritis, ankylosing spondylitis, Crohn's disease, ulcerative colitis, hidradenitis suppurativa, psoriasis, and uveitis the rate of infection was 147.4 per 100 patient-years in 5630 adalimumab-treated patients and 142.7 per 100 patient-years in 3587 control-treated patients. The infections consisted primarily of nasopharyngitis, upper respiratory tract infection, and sinusitis. Most patients continued on adalimumab after the infection resolved.

The incidence of serious infections was 3.4 per 100 patient-years in adalimumab-treated patients and 3.2 per 100 patient-years in placebo and active control-treated patients.

In controlled and open-label studies with adalimumab, serious infections such as legionellosis (0.02 per 100 patient-years) have been reported. No cases of listeriosis have been reported and therefore, an estimated rate of 0.01 per 100 patient-years was calculated. Both infections have been reported spontaneously during the post-marketing period.

In controlled and open-label studies with adalimumab, serious infections (including fatal infections, which occurred rarely) have been reported, which include reports of tuberculosis (including miliary and extra-pulmonary locations) and invasive opportunistic infections (e.g., disseminated histoplasmosis, pneumocystis carinii pneumonia, and aspergillosis). Most of the cases of tuberculosis occurred within the first eight months after initiation of therapy and may reflect recrudescence of latent disease.

In the double-blind controlled portion of two clinical trials with adalimumab in patients with UC, serious infections occurred in 4/480 patients treated with adalimumab; they were appendicitis (n=1), anal abscess (n=1), catheter sepsis (n=1) and salmonellosis (n=1). Serious infections occurred in 8 placebo patients. Opportunistic infections occurred in 7/480 patients treated with adalimumab; they were candidiasis (n=3), oesophageal candidiasis (n=1) and oral candidiasis (n=3). Opportunistic infections occurred in 3 placebo patients.

In the double-blind controlled portion of three clinical trials with adalimumab in patients with HS, serious infections occurred in 4/419 patients treated with adalimumab; they were Escherichia infection (n=1), genital infection bacterial (n=1), infection (n=1), pilonidal cyst (n=1) and pyelonephritis (n=1). Serious infections occurred in 2/366 placebo patients.

In the double-masked controlled portion of two clinical trials with adalimumab in patients with uveitis, serious infections occurred in 7/250 (2.8%) patients treated with adalimumab; they were

pneumonia (n = 2), and 1 each of bronchitis, pilonidal cyst, pneumonia Legionella, tuberculosis, upper respiratory tract infection and urinary tract infection. Serious infections occurred in 4/250 (1.6%) placebo patients. Opportunistic infections occurred in 7/250 patients treated with adalimumab; they were active tuberculosis (n = 1), latent tuberculosis (n = 4) and oral candidiasis (n = 2). Latent tuberculosis occurred in 1 placebo-treated patient.

### Pediatrics

In a controlled trial for polyarticular JIA (Study DE038), the rate of adverse events of infections was 238.5 per 100 patient-years in the adalimumab-treated JIA patients compared to 269.5 per 100 patient-years in control (placebo) treated patients, and the rate of serious infections was 6.1 per 100 patient-years in the adalimumab-treated JIA patients compared to 0 events in control (placebo) treated patients. In the open-label extension study (M11-327), the exposure-adjusted incidence rate of serious infections was increased in patients who received concomitant systemic corticosteroids and immunosuppressants in addition to treatment with adalimumab.

In an open-label trial for polyarticular JIA (Study M10-444), the rate of adverse events of infections was 206.2 per 100 patient-years while receiving adalimumab and the rate of serious infections was 6.7 per 100 patient-years while receiving adalimumab.

### **Injection Site Reactions**

In controlled trials in adults and children, 13% of patients treated with adalimumab developed injection site reactions (erythema and/or itching, hemorrhage, pain or swelling), compared to 7% of patients receiving placebo or active control. Injection site reactions generally did not necessitate discontinuation of the medicinal product.

### **Malignancies**

More cases of malignancy have been observed in adalimumab-treated patients compared to control-treated patients in clinical trials. See (WARNINGS AND PRECAUTIONS, Malignancies).

### **Neurologic Events**

In 21 controlled trials for adult patients with rheumatoid arthritis, psoriatic arthritis, ankylosing spondylitis, Crohn's disease, ulcerative colitis, hidradenitis suppurativa, and psoriasis the rate of new onset or exacerbation of central nervous system demyelinating disease (including multiple sclerosis and optic neuritis) and peripheral demyelinating disease (including Guillain-Barre syndrome) was less than 0.4 per 1000 patient-years in 5,380 adalimumab-treated patients and 0.7 per 1000 patient-years in 3,337 control-treated patients. In controlled and open-label studies for adult patients treated with adalimumab, the rate (95% CI) of demyelinating diseases was 0.7 (0.4, 1.1) per 1000 patient-years. Demyelinating diseases were reported spontaneously during the post-marketing period.

In the double-masked controlled portion of two clinical trials with adalimumab in adult patients with uveitis, 1 (0.4%) case of multiple sclerosis was reported in 250 patients treated with adalimumab. In the adult uveitis development program including the open-label study, the rate (95% CI) of demyelinating diseases (i.e., multiple sclerosis and optic neuritis) was 5.4 (2.2, 11.0) per 1000 patient-years.

See (**WARNINGS AND PRECAUTIONS, Neurologic Events**).

### **Psoriasis: New Onset and Worsening**

Cases of new onset psoriasis, including pustular psoriasis and palmoplantar psoriasis, and cases of worsening of pre-existing psoriasis have been reported with the use of TNF-blockers, including adalimumab. Many of these patients were taking concomitant immunosuppressants (e.g., methotrexate, corticosteroids). Some of these patients required hospitalization. Most patients had improvement of their psoriasis following discontinuation of their TNF-blocker. Some patients have had recurrences of the psoriasis when they were re-challenged with a different TNF-blocker. Discontinuation of adalimumab should be considered for severe cases and those that do not improve or that worsen despite topical treatments.

### **Liver Enzyme Elevations**

In controlled Phase 3 trials of adalimumab (40 mg subcutaneous every other week), in patients with RA and PsA with a control period duration ranging from 4 to 104 weeks, alanine aminotransferase (ALT) elevations  $\geq 3 \times$  ULN occurred in 3.7% of adalimumab-treated patients and 1.6% of control-treated patients. Since many of the patients in these trials were also taking medications that cause liver enzyme elevations (e.g., NSAIDs, MTX), the relationship between adalimumab and the liver enzyme elevations is not clear.

In controlled Phase 3 trials of adalimumab (initial doses of 160 mg and 80 mg, or 80 mg and 40 mg on Days 1 and 15, respectively, followed by 40 mg every other week), in adult patients with Crohn's disease with a control period duration ranging from 4 to 52 weeks, ALT elevations  $\geq 3 \times$  ULN occurred in 0.9% of adalimumab-treated patients and 0.9% of control-treated patients.

In controlled Phase 3 trials of adalimumab (initial doses of 160 mg and 80 mg on Days 1 and 15, respectively, followed by 40 mg every other week), in patients with UC with a control period duration ranging from 1 to 52 weeks, ALT elevations  $\geq 3 \times$  ULN occurred in 1.5% of adalimumab-treated patients and 1.0% of control-treated patients. The incidence of ALT elevations  $\geq 5 \times$  ULN was 0.5% in adalimumab-treated patients and 0.2% in control-treated patients.

In controlled Phase 3 trials of adalimumab (initial dose of 80 mg then 40 mg every other week), in patients with plaque psoriasis with a control period duration ranging from 12 to 24 weeks, ALT elevations  $\geq 3 \times$  ULN occurred in 1.8% of adalimumab-treated patients and 1.8% of control-treated patients.

In controlled Phase 3 trials of adalimumab (40 mg every other week), in patients with ankylosing spondylitis with a control period of 12 to 24 weeks, ALT elevations  $\geq 3 \times$  ULN occurred in 2.4% of adalimumab-treated patients and 0.7% of control-treated patients.

In controlled trials of adalimumab (initial doses of 160 mg at Week 0 and 80 mg at Week 2, followed by 40 mg every week starting at Week 4), in adult patients with hidradenitis suppurativa with a control period duration ranging from 12 to 16 weeks, ALT elevations  $\geq 3 \times$  ULN occurred in 0.3% of adalimumab-treated patients and 0.6% of control-treated patients.

In controlled Phase 3 trials of adalimumab (initial doses of 80 mg at Week 0 followed by 40 mg every other week starting at Week 1) in patients with adult uveitis with an exposure of 165.4 patient-years and 119.8 patient-years in adalimumab-treated and control-treated patients, respectively, ALT elevations  $\geq 3 \times$  ULN occurred in 2.4% of adalimumab-treated patients and 2.4% of control-treated patients.

Across all adult indications in clinical trials, patients with raised ALT were asymptomatic and in most cases elevations were transient and resolved on continued treatment. However, there have been very rare postmarketing reports of severe hepatic reactions including liver failure as well as less severe liver disorders that may precede liver failure, such as hepatitis including autoimmune hepatitis, in patients receiving TNF blockers, including adalimumab. The causal relationship to adalimumab treatment remains unclear.

### Concurrent treatment with azathioprine/6-mercaptopurine

In adult Crohn's disease studies, higher incidences of malignant and serious infection-related adverse events were seen with the combination of adalimumab and azathioprine/6-mercaptopurine compared with adalimumab alone.

## 9.2 Clinical Trial Adverse Reactions

Because clinical trials are conducted under very specific conditions, the adverse reaction rates observed in the clinical trials may not reflect the rates observed in practice and should not be compared to the rates in the clinical trials of another drug. Adverse reaction information from clinical trials is useful for identifying drug-related adverse events and for approximating rates.

### Pediatric

#### Polyarticular Juvenile Idiopathic Arthritis

**Table 2. Number and Percentage of Subjects with  $\geq 1\%$  Treatment-Emergent Adverse Events at Least Possibly Related to Study Drug During the Double Blind Placebo-Controlled Phase in the Polyarticular JIA Trial (Study DE038)**

System Organ Class MedDRA 12.1 Preferred Term	MTX		Non-MTX		Overall	
	Placebo N = 37 n (%)	Adalimumab N = 38 n (%)	Placebo N = 28 n (%)	Adalimumab N = 30 n (%)	Placebo N = 65 n (%)	Adalimumab N = 68 n (%)
<b>Any at least possibly related adverse event</b>	17 (45.9)	22 (57.9)	9 (32.1)	16 (53.3)	26 (40.0)	38 (55.9)
<b>Blood and Lymphatic System Disorders</b>	0	2 (5.3)	0	1 (3.3)	0	3 (4.4)
Leukopenia	0	1 (2.6)	0	0	0	1 (1.5)
Neutropenia	0	1 (2.6)	0	1 (3.3)	0	2 (2.9)
<b>Ear and Labyrinth Disorders</b>	0	0	0	1 (3.3)	0	1 (1.5)
Ear pain	0	0	0	1 (3.3)	0	1 (1.5)
<b>Gastrointestinal Disorders</b>	1 (2.7)	1 (2.6)	0	0	1 (1.5)	1 (1.5)
Gastroduodenitis	1 (2.7)	0	0	0	1 (1.5)	0
Vomiting	0	1 (2.6)	0	0	0	1 (1.5)

System Organ Class MedDRA 12.1 Preferred Term	MTX		Non-MTX		Overall	
	Placebo N = 37 n (%)	Adalimumab N = 38 n (%)	Placebo N = 28 n (%)	Adalimumab N = 30 n (%)	Placebo N = 65 n (%)	Adalimumab N = 68 n (%)
<b>General Disorders and Administration Site Conditions</b>	10 (27.0)	15 (39.5)	6 (21.4)	11 (36.7)	16 (24.6)	26 (38.2)
Application site reaction	1 (2.7)	1 (2.6)	0	0	1 (1.5)	1 (1.5)
Fatigue	0	0	0	1 (3.3)	0	1 (1.5)
Influenza like illness	1 (2.7)	0	0	0	1 (1.5)	0
Injection site erythema	1 (2.7)	2 (5.3)	0	1 (3.3)	1 (1.5)	3 (4.4)
Injection site haematoma	0	1 (2.6)	0	0	0	1 (1.5)
Injection site hypersensitivity	1 (2.7)	0	0	0	1 (1.5)	0
Injection site pain	7 (18.9)	7 (18.4)	3 (10.7)	9 (30.0)	10 (15.4)	16 (23.5)
Injection site pruritus	0	1 (2.6)	0	1 (3.3)	0	2 (2.9)
Injection site reaction	1 (2.7)	7 (18.4)	1 (3.6)	3 (10.0)	2 (3.1)	10 (14.7)
Pain	0	1 (2.6)	2 (7.1)	2 (6.7)	2 (3.1)	3 (4.4)
Pyrexia	0	2 (5.3)	0	0	0	2 (2.9)
<b>Immune System Disorder</b>	0	1 (2.6)	0	1 (3.3)	0	2 (2.9)
Hypersensitivity	0	1 (2.6)	0	1 (3.3)	0	2 (2.9)
<b>Infections and Infestations</b>	7 (18.9)	10 (26.3)	3 (10.7)	6 (20.0)	10 (15.4)	16 (23.5)
Acute tonsillitis	1 (2.7)	1 (2.6)	0	0	1 (1.5)	1 (1.5)
Bronchitis	1 (2.7)	0	0	1 (3.3)	1 (1.5)	1 (1.5)
Ear infection	0	1 (2.6)	0	1 (3.3)	0	2 (2.9)
Folliculitis	1 (2.7)	0	0	0	1 (1.5)	0
Fungal infection	0	0	1 (3.6)	0	1 (1.5)	0
Herpes simplex	0	0	0	1 (3.3)	0	1 (1.5)
Herpes virus infection	0	0	0	1 (3.3)	0	1 (1.5)
Impetigo	0	1 (2.6)	0	1 (3.3)	0	2 (2.9)
Influenza	0	1 (2.6)	1 (3.6)	1 (3.3)	1 (1.5)	2 (2.9)
Molluscum contagiosum	1 (2.7)	0	0	0	1 (1.5)	0
Oral herpes	1 (2.7)	1 (2.6)	0	0	1 (1.5)	1 (1.5)
Paronychia	0	1 (2.6)	0	0	0	1 (1.5)
Pharyngotonsillitis	1 (2.7)	0	0	1 (3.3)	1 (1.5)	1 (1.5)
Rhinitis	0	2 (5.3)	0	1 (3.3)	0	3 (4.4)
Sinusitis	0	1 (2.6)	0	0	0	1 (1.5)
Staphylococcal skin infection	0	0	1 (3.6)	0	1 (1.5)	0
Upper respiratory tract infection	2 (5.4)	3 (7.9)	0	2 (6.7)	2 (3.1)	5 (7.4)
Urinary tract infection	0	1 (2.6)	0	0	0	1 (1.5)
Viral infection	1 (2.7)	3 (7.9)	0	0	1 (1.5)	3 (4.4)
Viral upper respiratory tract infection	0	0	0	1 (3.3)	0	1 (1.5)
<b>Injury, Poisoning and Procedural Complications</b>	1 (2.7)*	0*	1 (3.6)*	0*	2 (3.1)*	0*
Excoriation <sup>†</sup>	1 (2.7)	4 (10.5)	1 (3.6)	3 (10.0)	2 (3.1)	7 (10.3)
Injury	0	0	1 (3.6)	0	1 (1.5)	0
Scratch	1 (2.7)	0	0	0	1 (1.5)	0
<b>Investigations</b>	0	1 (2.6)	0	0	0	1 (1.5)
Lymphocyte count increased	0	1 (2.6)	0	0	0	1 (1.5)
Neutrophil count decreased	0	1 (2.6)	0	0	0	1 (1.5)

System Organ Class MedDRA 12.1 Preferred Term	MTX		Non-MTX		Overall	
	Placebo N = 37 n (%)	Adalimumab N = 38 n (%)	Placebo N = 28 n (%)	Adalimumab N = 30 n (%)	Placebo N = 65 n (%)	Adalimumab N = 68 n (%)
<b>Metabolism and Nutrition Disorders</b>	1 (2.7)	0	0	0	1 (1.5)	0
Enzyme abnormality	1 (2.7)	0	0	0	1 (1.5)	0
<b>Musculoskeletal and Connective Tissue Disorders</b>	3 (8.1)	1 (2.6)	0	1 (3.3)	3 (4.6)	2 (2.9)
Arthralgia	0	0	0	1 (3.3)	0	1 (1.5)
Groin pain	1 (2.7)	0	0	0	1 (1.5)	0
Juvenile arthritis	1 (2.7)	0	0	0	1 (1.5)	1 (1.5)
Rheumatoid arthritis	1 (2.7)	1 (2.6)	0	0	1 (1.5)	0
<b>Nervous System Disorders</b>	1 (2.7)	0	0	1 (3.3)	1 (1.5)	1 (1.5)
Headache	1 (2.7)	0	0	1 (3.3)	1 (1.5)	1 (1.5)
<b>Renal and Urinary Disorders</b>	0	0	2 (7.1)	0	2 (3.1)	0
Dysuria	0	0	1 (3.6)	0	1 (1.5)	0
Proteinuria	0	0	1 (3.6)	0	1 (1.5)	0
<b>Respiratory, Thoracic and Mediastinal Disorders</b>	0	2 (5.3)	0	1 (3.3)	0	3 (4.4)
Asthma	0	1 (2.6)	0	0	0	1 (1.5)
Cough	0	0	0	1 (3.3)	0	1 (1.5)
Epistaxis	0	1 (2.6)	0	0	0	1 (1.5)
<b>Skin and Subcutaneous Tissue Disorders</b>	1 (2.7)*	1 (2.6)*	0	1 (3.3)*	0	2 (2.9)*
Acne	0	0	0	1 (3.3)	0	1 (1.5)
Dermatitis	1 (2.7)	0	0	0	0	0
Rash†	0	1 (2.6)	0	2 (6.7)	0	3 (4.4)
Rash papular	0	0	0	1 (3.3)	0	1 (1.5)
Skin lesion	0	1 (2.6)	0	0	0	1 (1.5)

\* Total only includes values for the terms that were considered possibly or probably related by the investigator.

† Term was not considered possibly or probably related as assessed by the investigator; however, these terms were considered more common in patients treated with adalimumab vs. placebo in the clinical trial.

In Study DE038, adalimumab was studied in 171 patients aged 4 to 17 years with polyarticular JIA. Serious adverse events were observed in 28% of patients treated with adalimumab and included neutropenia, streptococcal pharyngitis, increased aminotransferases, herpes zoster, myositis, metrorrhagia and appendicitis. Serious infections were observed in 6.4% of patients treated with adalimumab and included cases of herpes zoster, appendicitis, pneumonia, urinary tract infection, streptococcal pharyngitis, viral infection and cervicitis. A total of 45% of patients experienced an infection while receiving adalimumab with or without concomitant MTX in the first 16 weeks of treatment (see **WARNINGS AND PRECAUTIONS, Infections**). Granuloma annulare was reported in two patients (see **WARNINGS AND PRECAUTIONS, Malignancies**).

During the double-blind phase of Study DE038, the most common ( $\geq 5\%$ ) adverse reactions occurring in the JIA population treated with adalimumab were viral infection (18%), injection site pain (18%), upper respiratory tract infection (16%), injection site reaction (15%), contusion (13%), excoriation (10%), rhinitis (7%), vomiting (6%) and drug hypersensitivity (6%).

Throughout Study DE038, 6% of patients had mild to moderate allergic reaction adverse events

primarily localized allergic hypersensitivity reactions and urticaria (see **WARNINGS AND PRECAUTIONS, Hypersensitivity Reactions**).

In the JIA trial, 10% of patients treated with adalimumab who were negative at baseline for anti-double-stranded DNA antibodies developed positive titers after 48 weeks of treatment (see **ADVERSE REACTIONS, Adverse Drug Reaction Overview, Immunogenicity, Pediatric**).

In Study M10-444, adalimumab was studied in 32 patients who were 2 to <4 years of age or 4 years of age and older weighing <15 kg with polyarticular JIA. The safety profile for this patient population was similar to the safety profile seen in Study DE038.

In Study M10-444, 78% of patients experienced an infection while receiving adalimumab. These included nasopharyngitis, bronchitis, upper respiratory tract infection, otitis media, and were mostly mild to moderate in severity. Serious infections were observed in 9% of patients receiving adalimumab in the study and included dental caries, rotavirus gastroenteritis, and varicella.

In Study M10-444, non-serious allergic reactions were observed in 6% of patients and included intermittent urticaria and rash, which were all mild in severity.

## **Adult**

### Rheumatoid Arthritis

#### **Description of Data Sources**

The data described below reflect exposure to adalimumab in 3,046 patients, including more than 2,000 patients exposed for six months, and more than 1,500 exposed for more than one year (Studies DE009, DE011, DE019, DE031 and DE013). Adalimumab was studied in placebo-controlled trials and in long-term follow-up studies for up to 60 months duration in patients with moderately to severely active rheumatoid arthritis who had failed previous DMARD therapy; the mean age was 54 years, 77% were female and 91% Caucasian (Studies DE009, DE011, DE019, DE031). A further study (Study DE013) was in patients with recently diagnosed rheumatoid arthritis who had not previously been treated with methotrexate. Most patients received adalimumab 40 mg every other week.

#### **Relative Frequency of Adverse Drug Reactions**

**Table 3** summarizes adverse drug reactions reported at a rate of at least 1% in patients treated with adalimumab 40 mg every other week, as well as all doses of adalimumab tested, compared to placebo or methotrexate (Study DE013). Adverse reaction rates in patients treated with adalimumab 40 mg weekly were similar to rates in patients treated with adalimumab every other week. In Study DE019, the types and frequencies of adverse drug reactions in the 10-year open-label extension were similar to those observed in the one-year double-blind portion.

**Table 3. Number and Percentage of Patients with  $\geq$  1% Treatment-Emergent Adverse Events at Least Possibly Related to Study Drug During the Control Period in Rheumatoid Arthritis Studies (Studies DE009, DE011, DE019, DE031, DE013)**



<b>System Organ Class (SOC)</b>	<b>Adalimumab 40 mg s.c. eow N = 1247 n (%)</b>	<b>Adalimumab (all adalimumab) N = 1922 n (%)</b>	<b>Placebo (not Study DE013) N = 690 n (%)</b>	<b>MTX (Study DE013) N = 257 n (%)</b>
<b>Gastrointestinal Disorders</b>				
Nausea	80 (6.4)	112 (5.8)	12 (1.7)	33 (12.8)
Diarrhea	47 (3.8)	60 (3.1)	17 (2.5)	18 (7.0)
Abdominal pain	22 (1.8)	29 (1.5)	5 (0.7)	3 (1.2)
Abdominal pain upper	20 (1.6)	25 (1.3)	0 (0.0)	13 (5.1)
Mouth ulceration	17 (1.4)	24 (1.2)	5 (0.7)	12 (4.7)
Dyspepsia	14 (1.1)	21 (1.1)	4 (0.6)	7 (2.7)
Vomiting	16 (1.3)	20 (1.0)	5 (0.7)	6 (2.3)
<b>General Disorders and Administration Site Conditions</b>				
Injection site irritation	74 (5.9)	122 (6.3)	61 (8.8)	3 (1.2)
Injection site reaction	49 (3.9)	67 (3.5)	3 (0.4)	2 (0.8)
Injection site pain	36 (2.9)	63 (3.3)	24 (3.5)	6 (2.3)
Injection site erythema	36 (2.9)	60 (3.1)	2 (0.3)	1 (0.4)
Fatigue	37 (3.0)	58 (3.0)	7 (1.0)	9 (3.5)
Injection site rash	17 (1.4)	22 (1.1)	2 (0.3)	0 (0.0)
Influenza-like illness	15 (1.2)	21 (1.1)	2 (0.3)	8 (3.1)
Pyrexia	13 (1.0)	20 (1.0)	1 (0.1)	6 (2.3)
<b>Infections and Infestations</b>				
Nasopharyngitis	61 (4.9)	95 (4.9)	10 (1.5)	28 (10.9)
Upper respiratory infection	72 (5.8)	93 (4.8)	15 (2.2)	17 (6.6)
Sinusitis	46 (3.7)	55 (2.9)	17 (2.5)	4 (1.6)
Herpes simplex	33 (2.6)	48 (2.5)	6 (0.9)	5 (1.9)
Urinary tract infection	31 (2.5)	44 (2.3)	6 (0.9)	7 (2.7)
Bronchitis	19 (1.5)	29 (1.5)	8 (1.2)	9 (3.5)
Herpes zoster	17 (1.4)	23 (1.2)	8 (1.2)	2 (0.8)
Influenza	16 (1.3)	21 (1.1)	7 (1.0)	5 (1.9)
Pneumonia	17 (1.4)	21 (1.1)	3 (0.4)	1 (0.4)
<b>Investigations</b>				
Lymphocyte count decreased	11 (0.9)	38 (2.0)	11 (1.6)	1 (0.4)
Alanine aminotransferase increased	27 (2.2)	33 (1.7)	4 (0.6)	9 (3.5)
Liver function test abnormal	19 (1.5)	22 (1.1)	4 (0.6)	7 (2.7)
<b>Musculoskeletal and Connective Tissue Disorders</b>				
Rheumatoid arthritis	11 (0.9)	28 (1.5)	7 (1.0)	2 (0.8)
<b>Nervous System Disorders</b>				
Headache	75 (6.0)	124 (6.5)	14 (2.0)	14 (5.4)
Dizziness	23 (1.8)	32 (1.7)	6 (0.9)	3 (1.2)
<b>Respiratory, Thoracic and Mediastinal Disorders</b>				
Pharyngolaryngeal pain	33 (2.6)	44 (2.3)	9 (1.3)	7 (2.7)
Cough	31 (2.5)	42 (2.2)	4 (0.6)	9 (3.5)
<b>Skin and Subcutaneous Tissue Disorders</b>				
Rash	44 (3.5)	66 (3.4)	9 (1.3)	8 (3.1)
Pruritus	28 (2.2)	43 (2.2)	4 (0.6)	5 (1.9)
Alopecia	22 (1.8)	28 (1.5)	2 (0.3)	6 (2.3)
Rash pruritic	14 (1.1)	22 (1.1)	0 (0.0)	3 (1.2)

Definition(s): s.c. = subcutaneous ; eow = every other week

## Psoriatic Arthritis

**Table 4** summarizes adverse drug reactions reported in placebo-controlled and open-label studies at a rate of at least 1% in psoriatic arthritis patients treated with adalimumab 40 mg every other week.

**Table 4. Number and Percentage of Patients with  $\geq$  1% Treatment-Emergent Adverse Events at Least Possibly Related to Study Drug During the Control and Open-Label Periods in Psoriatic Arthritis Studies (Studies M02-518, M02-570, and M02-537)**

System Organ Class (SOC)	Double-Blind Study		Open-Label Study
	Placebo N = 211 n (%)	Adalimumab 40 mg s.c. eow N = 202 n (%)	Adalimumab 40 mg s.c. eow N = 382 n (%)
<b>Gastrointestinal Disorders</b>			
Nausea	2 (0.9)	2 (1.0)	3 (0.8)
<b>General Disorders and Administration Site Conditions</b>			
Injection site reaction	5 (2.4)	11 (5.4)	21 (5.5)
Injection site pain	8 (3.8)	8 (4.0)	2 (0.5)
Injection site erythema	0 (0.0)	4 (2.0)	2 (0.5)
Injection site burning	4 (1.9)	4 (2.0)	4 (1.0)
Fatigue	5 (2.4)	0 (0.0)	4 (1.0)
<b>Infections and Infestations</b>			
Upper respiratory infection	7 (3.3)	8 (4.0)	17 (4.5)
Herpes simplex	3 (1.4)	6 (3.0)	7 (1.8)
Skin fungal infection NOS	0 (0.0)	3 (1.5)	-
Pharyngitis	1 (0.5)	2 (1.0)	4 (1.0)
Sinusitis	4 (1.9)	2 (1.0)	12 (3.1)
Urinary tract infection	0 (0.0)	2 (1.0)	6 (1.6)
Bronchitis	1 (0.5)	1 (0.5)	5 (1.3)
Nasopharyngitis	2 (0.9)	1 (0.5)	8 (2.1)
Influenza	2 (0.9)	0 (0.0)	5 (1.3)
<b>Investigations</b>			
Liver function tests abnormal	1 (0.5)	2 (1.0)	5 (1.3)
<b>Nervous System Disorders</b>			
Headache	5 (2.4)	5 (2.5)	5 (1.3)
Paresthesia	1 (0.5)	3 (1.5)	2 (0.5)
<b>Respiratory, Thoracic, and Mediastinal Disorders</b>			
Rhinitis NOS	0 (0.0)	3 (1.5)	3 (0.8)
<b>Skin and Subcutaneous Tissue Disorders</b>			
Erythema	0 (0.0)	3 (1.5)	-

Definition(s): s.c. = subcutaneous; eow = every other week

## Ankylosing Spondylitis

Adalimumab has been studied in 393 patients with ankylosing spondylitis in two placebo-controlled studies. The safety profile for patients with ankylosing spondylitis treated with adalimumab 40 mg every other week was similar to the safety profile seen in patients with rheumatoid arthritis, adalimumab Studies DE009, DE011, DE019, and DE031. **Table 5** summarizes adverse drug reactions reported at a rate of at least 1% in ankylosing spondylitis patients treated with adalimumab 40 mg every other week compared to placebo.

**Table 5. Number and Percentage of Patients with  $\geq$  1% Treatment-Emergent Adverse Events at Least Possibly Related to Study Drug During the Control Period in Ankylosing Spondylitis Studies (Studies M03-607 and M03-606)**

System Organ Class (SOC)	Adalimumab 40 mg s.c. eow N = 246 n (%)	Placebo N = 151 n (%)
<b>General Disorders and Administration Site Conditions</b>		
Fatigue	5 (2.0)	3 (2.0)
Injection site erythema	5 (2.0)	1 (0.7)
Injection site irritation	4 (1.6)	2 (1.3)
Injection site pain	6 (2.4)	3 (2.0)
Injection site reaction	8 (3.3)	1 (0.7)
<b>Infections and Infestations</b>		
Nasopharyngitis	8 (3.3)	0 (0.0)
Upper respiratory tract infection	5 (2.0)	2 (1.3)
<b>Nervous System Disorders</b>		
Dizziness	3 (1.2)	3 (2.0)
Headache	11 (4.5)	4 (2.6)
<b>Skin and Subcutaneous Tissue Disorders</b>		
Eczema	3 (1.2)	1 (0.7)
Pruritus	4 (1.6)	1 (0.7)
Pruritus generalized	3 (1.2)	0 (0.0)
Rash	4 (1.6)	1 (0.7)
Urticaria	3 (1.2)	0 (0.0)

Definition(s): s.c. = subcutaneous; eow = every other week

### Crohn's Disease

Adalimumab has been studied in over 1,500 patients with Crohn's disease in five placebo-controlled and two open-label extension studies. The safety profile for patients with Crohn's disease treated with adalimumab was similar to the safety profile seen in patients with rheumatoid arthritis including the safety profile for patients in placebo-controlled Study M05-769. No new safety signals occurred during the open-label long-term studies with adalimumab exposure up to five years. The safety profile of adalimumab in Crohn's disease remains unaltered.

**Table 6** and **Table 7** summarize adverse drug reactions reported at a rate of at least 1% in Crohn's disease patients treated with adalimumab in induction and maintenance studies, respectively.

**Table 6. Number and Percentage of Patients with  $\geq$  1% Treatment-Emergent Adverse Events at Least Possibly Related to Study Drug During Administration of Induction Study Medications in Crohn's Disease Studies (Studies M02-403 and M04-691)**

System Organ Class (SOC)	Adalimumab 160/80 mg N = 235 n (%)	Adalimumab 80/40 mg N = 75 n (%)	Placebo N = 240 n (%)
<b>Eye Disorders</b>			
Corneal pigmentation	0 (0.0)	1 (1.3)	0 (0.0)
Visual disturbance	0 (0.0)	1 (1.3)	0 (0.0)
<b>Gastrointestinal Disorders</b>			
Abdominal pain	5 (2.1)	0 (0.0)	2 (0.8)

<b>System Organ Class (SOC)</b>	<b>Adalimumab 160/80 mg N = 235 n (%)</b>	<b>Adalimumab 80/40 mg N = 75 n (%)</b>	<b>Placebo N = 240 n (%)</b>
Abdominal pain lower	3 (1.3)	0 (0.0)	0 (0.0)
Change of bowel habit	0 (0.0)	1 (1.3)	0 (0.0)
Cheilitis	0 (0.0)	1 (1.3)	1 (0.4)
Constipation	2 (0.9)	1 (1.3)	3 (1.3)
Crohn's disease	2 (0.9)	1 (1.3)	3 (1.3)
Flatulence	3 (1.3)	0 (0.0)	0 (0.0)
Nausea	6 (2.6)	0 (0.0)	4 (1.7)
Vomiting	1 (0.4)	1 (1.3)	3 (1.3)
<b>General Disorders and Administration Site Conditions</b>			
Asthenia	0 (0.0)	1 (1.3)	1 (0.4)
Chills	0 (0.0)	2 (2.7)	1 (0.4)
Fatigue	2 (0.9)	1 (1.3)	10 (4.2)
Influenza like illness	0 (0.0)	2 (2.7)	2 (0.8)
Injection site bruising	5 (2.1)	1 (1.3)	1 (0.4)
Injection site erythema	4 (1.7)	0 (0.0)	0 (0.0)
Injection site irritation	19 (8.1)	8 (10.7)	14 (5.8)
Injection site pain	6 (2.6)	4 (5.3)	9 (3.8)
Injection site pruritus	3 (1.3)	0 (0.0)	0 (0.0)
Injection site reaction	11 (4.7)	5 (6.7)	6 (2.5)
Pain	2 (0.9)	1 (1.3)	3 (1.3)
Pyrexia	3 (1.3)	3 (1.3)	3 (1.3)
<b>Infections and Infestations</b>			
Staphylococcal infection	0 (0.0)	1 (1.3)	0 (0.0)
<b>Investigations</b>			
Double stranded DNA antibody	0 (0.0)	1 (1.3)	0 (0.0)
White blood cell count increased	0 (0.0)	1 (1.3)	0 (0.0)
<b>Metabolism and Nutrition Disorders</b>			
Hypokalemia	0 (0.0)	1 (1.3)	0 (0.0)
<b>Musculoskeletal and Connective Tissue Disorders</b>			
Arthralgia	3 (1.3)	1 (1.3)	2 (0.8)
Back pain	0 (0.0)	1 (1.3)	0 (0.0)
Muscle spasms	0 (0.0)	1 (1.3)	1 (0.4)
Pain in extremity	0 (0.0)	1 (1.3)	0 (0.0)
<b>Nervous System Disorders</b>			
Dizziness	3 (1.3)	0 (0.0)	2 (0.8)
Headache	8 (3.4)	2 (2.7)	7 (2.9)
Restless legs syndrome	0 (0.0)	1 (1.3)	0 (0.0)
<b>Reproductive System and Breast Disorders</b>			
Genital pruritus female	0 (0.0)	1 (1.3)	0 (0.0)
<b>Skin and Subcutaneous Tissue Disorders</b>			
Eczema	1 (0.4)	1 (1.3)	0 (0.0)
Erythema	1 (0.4)	1 (1.3)	1 (0.4)
Hyperhidrosis	0 (0.0)	1 (1.3)	0 (0.0)
Onychorrhexis	0 (0.0)	1 (1.3)	0 (0.0)
Pruritus	1 (0.4)	0 (0.0)	4 (1.7)
Rash	2 (0.9)	2 (2.7)	1 (0.4)
Rash maculo-papular	1 (0.4)	1 (1.3)	0 (0.0)

System Organ Class (SOC)	Adalimumab 160/80 mg N = 235 n (%)	Adalimumab 80/40 mg N = 75 n (%)	Placebo N = 240 n (%)
Rash pruritic	0 (0.0)	1 (1.3)	1 (0.4)

**Table 7. Number and Percentage of Patients with  $\geq$  1% Treatment-Emergent Adverse Events at Least Possibly Related to Study Drug During Administration of Blinded Study Maintenance Medications in Crohn's Disease Studies (Studies M02-404 and M02-433)**

System Organ Class (SOC)	Adalimumab 40 mg s.c. eow, 40 mg ew N = 554 n (%)	Placebo N = 279 n (%)
<b>Gastrointestinal Disorders</b>		
Abdominal pain	7 (1.3)	4 (1.4)
Crohn's disease	9 (1.6)	9 (3.2)
Diarrhea	7 (1.3)	1 (0.4)
Nausea	9 (1.6)	5 (1.8)
<b>General Disorders and Administration Site Conditions</b>		
Fatigue	10 (1.8)	1 (0.4)
Injection site bruising	6 (1.1)	1 (0.4)
Injection site erythema	10 (1.8)	0 (0.0)
Injection site irritation	18 (3.2)	2 (0.7)
Injection site pain	8 (1.4)	2 (0.7)
Injection site reaction	26 (4.7)	1 (0.4)
Pyrexia	7 (1.3)	5 (1.8)
<b>Infections and Infestations</b>		
Herpes simplex	6 (1.1)	4 (1.4)
Nasopharyngitis	8 (1.4)	2 (0.7)
Rhinitis	7 (1.3)	1 (0.4)
<b>Musculoskeletal and Connective Tissue Disorders</b>		
Arthralgia	9 (1.6)	2 (0.7)
<b>Nervous System Disorders</b>		
Headache	19 (3.4)	6 (2.2)
<b>Skin and Subcutaneous Tissue Disorders</b>		
Rash	11 (2.0)	5 (1.8)

Definition(s): s.c. = subcutaneous; ew = every week; eow = every other week

#### Ulcerative Colitis

Adalimumab has been studied in 1,010 patients with ulcerative colitis (UC) in two placebo-controlled studies and one open-label extension study. The safety profile for patients with UC treated with adalimumab was similar to the safety profile observed in patients with Crohn's Disease.

**Table 8** and **Table 9** summarize adverse drug reactions reported at a rate of at least 1% in ulcerative colitis disease patients treated with adalimumab during induction and maintenance periods, respectively.

**Table 8. Number and Percentage of Subjects  $\geq$  1% Reporting Treatment-Emergent Adverse Events at Least Possibly Related to Study Drug During Administration of Induction**

**Study Medications in Ulcerative Colitis Studies (Studies M06-826 and M06-827)**

<b>System Organ Class (SOC)</b>	<b>Adalimumab 160/80 mg N = 480 n (%)</b>	<b>Adalimumab 80/40 mg N = 130 n (%)</b>	<b>Placebo N = 483 n (%)</b>
<b>Gastrointestinal Disorders</b>	17 (3.5)	7 (5.4)	27 (5.6)
Abdominal pain	0 (0.0)	2 (1.5)	2 (0.4)
Colitis Ulcerative	7 (1.5)	2 (1.5)	8 (1.7)
Nausea	6 (1.3)	1 (0.8)	7 (1.4)
<b>General Disorders and Administration Site Conditions</b>	44 (9.2)	8 (6.2)	34 (7.0)
Fatigue	9 (1.9)	1 (0.8)	7 (1.4)
Influenza like illness	1 (0.2)	1 (0.8)	5 (1.0)
Injection site erythema	8 (1.7)	1 (0.8)	2 (0.4)
Injection site haematoma	2 (0.4)	2 (1.5)	0 (0.0)
Injection site pain	11 (2.3)	2 (1.5)	11 (2.3)
Injection site pruritus	6 (1.3)	1 (0.8)	1 (0.2)
Injection site reaction	5 (1.0)	1 (0.8)	2 (0.4)
Pyrexia	3 (0.6)	1 (0.8)	7 (1.4)
<b>Infections and Infestations</b>	19 (4.0)	7 (5.4)	24 (5.0)
Herpes simplex	0 (0.0)	2 (1.5)	0 (0.0)
Nasopharyngitis	5 (1.0)	1 (0.8)	4 (0.8)
Oral herpes	2 (0.4)	2 (1.5)	2 (0.4)
<b>Nervous System Disorders</b>	14 (2.9)	2 (1.5)	25 (5.2)
Headache	7 (1.5)	2 (1.5)	20 (4.1)
<b>Psychiatric Disorders</b>	1 (0.2)	2 (1.5)	4 (0.8)
Anxiety	0 (0.0)	2 (1.5)	0 (0.0)
<b>Skin and Subcutaneous Tissue Disorders</b>	19 (4.0)	8 (6.2)	17 (3.5)
Erythema	5 (1.0)	2 (1.5)	1 (0.2)
Rash	2 (0.4)	2 (3.1)	1 (0.2)

**Table 9. Number and Percentage of Subjects ≥ 1% Reporting Treatment-Emergent Adverse Events at Least Possibly Related to Study Drug During the Double-blind Induction and Maintenance Periods of Ulcerative Colitis Studies (Studies M06-826 and M06-827)**

<b>System Organ Class (SOC)</b>	<b>Adalimumab 160/80 mg N = 480 n (%)</b>	<b>Placebo N = 483 n (%)</b>
<b>Gastrointestinal Disorders</b>	31 (6.5)	36 (7.5)
Colitis ulcerative	12 (2.5)	14 (2.9)
Nausea	9 (1.9)	9 (1.9)
<b>General Disorders And Administration Site Conditions</b>	64 (13.3)	38 (7.9)
Fatigue	10 (2.1)	8 (1.7)
Influenza like illness	3 (0.6)	5 (1.0)
Injection site erythema	15 (3.1)	3 (0.6)
Injection site pain	11 (2.3)	12 (2.5)
Injection site pruritus	9 (1.9)	2 (0.4)
Injection site reaction	11 (2.3)	2 (0.4)
Injection site swelling	5 (1.0)	0 (0.0)

<b>System Organ Class (SOC)</b>	<b>Adalimumab 160/80 mg N = 480 n (%)</b>	<b>Placebo N = 483 n (%)</b>
Malaise	5 (1.0)	2 (0.4)
Oedema peripheral	5 (1.0)	1 (0.2)
Pyrexia	3 (0.6)	9 (1.9)
<b>Infections And Infestations</b>	40 (8.3)	42 (8.7)
Influenza	0 (0.0)	5 (1.0)
Nasopharyngitis	9 (1.9)	7 (1.4)
Upper respiratory tract infection	5 (1.0)	7 (1.4)
<b>Musculoskeletal And Connective Tissue Disorders</b>	12 (2.5)	12 (2.5)
Arthralgia	5 (1.0)	4 (0.8)
<b>Nervous System Disorders</b>	19 (4.0)	28 (5.8)
Headache	10 (2.1)	22 (4.6)
<b>Skin And Subcutaneous Tissue Disorders</b>	38 (7.9)	29 (6.0)
Erythema	6 (1.3)	2 (0.4)
Pruritus	5 (1.0)	5 (1.0)
Rash	7 (1.5)	5 (1.0)

Serious adverse events resulting in hospitalizations were reported by 18% (67/379) in the adalimumab-treated patients compared to 26% (56/214) in the placebo group adjusted for patient years at risk.

During the double-blind controlled clinical trials, the most common ( $\geq 5\%$ ) adverse drug reactions in subjects receiving adalimumab 160/80 during induction were ulcerative colitis (n=35, 7.3%) and nasopharyngitis (n=26, 5.4%), and during maintenance were ulcerative colitis (n=38, 16.2%), nasopharyngitis (n=26, 11.1%), abdominal pain (n=17, 7.3%), and arthralgia (n=17, 7.3%). There were 2/480 adalimumab-treated patients who experienced severe leukopenia of which one case was serious. The patient with serious leukopenia, which was considered secondary to 6-MP, had an associated viral infection.

During the double-blind controlled clinical trials, the most common serious adverse event occurring in >1 patient more often in the adalimumab-treated patients compared to placebo when adjusted for exposure was deep vein thrombosis reported in 2 patients (4%, 1.12 events/100 patient-years).

During the double-blind controlled clinical trials, severe adverse events reported in >1 patient occurring more often in the adalimumab-treated patients compared to placebo when adjusted for exposure were deep vein thrombosis reported in 3 patients (0.6%, 1.68 events/100 patient years), and constipation, leukopenia and fatigue, which were reported in 2 patients (0.4%, 1.12 events/100 patients-years).

The most common adverse event associated with discontinuation reported in >1 subject during induction and maintenance was ulcerative colitis [n=18 (3.8%) and n=8 (3.4%), respectively].

#### Hidradenitis Suppurativa

Adalimumab has been studied in 727 adult patients with hidradenitis suppurativa in three

placebo-controlled studies and one open-label extension study.

**Table 10** summarizes adverse drug reactions reported at a rate of at least 1% in hidradenitis suppurativa patients treated with adalimumab during the placebo-controlled portion of the studies.

**Table 10. Number and Percentage of Patients  $\geq$  1% Reporting Treatment-Emergent Adverse Events at Least Possibly Related to Study Drug in Controlled Hidradenitis Suppurativa Studies (Studies M10-467, M11-313 and M11-810)**

System Organ Class (SOC)	Adalimumab 40 mg Every other week N = 52 n (%)	Adalimumab 40 mg weekly N = 367 n (%)	Placebo N = 366 n (%)
<b>Eye Disorders</b>			
Cataract	1 (1.9)	0 (0.0)	0 (0.0)
Conjunctivitis	1 (1.9)	0 (0.0)	0 (0.0)
Vision blurred	1 (1.9)	1 (0.3)	0 (0.0)
<b>Gastrointestinal Disorders</b>			
Abdominal pain	1 (1.9)	1 (0.3)	0 (0.0)
Abdominal pain upper	1 (1.9)	0 (0.0)	0 (0.0)
Diarrhoea	1 (1.9)	8 (2.2)	3 (0.8)
Nausea	1 (1.9)	6 (1.6)	8 (2.2)
Vomiting	1 (1.9)	3 (0.8)	3 (0.8)
Asthenia	0 (0.0)	1 (0.3)	5 (1.4)
Chills	1 (1.9)	0 (0.0)	1 (0.3)
Fatigue	1 (1.9)	4 (1.1)	4 (1.1)
Injection site erythema	0 (0.0)	5 (1.4)	0 (0.0)
Injection site pain	0 (0.0)	6 (1.6)	6 (1.6)
Injection site pruritus	0 (0.0)	5 (1.4)	0 (0.0)
Injection site reaction	1 (1.9)	3 (0.8)	1 (0.3)
Oedema	1 (1.9)	0 (0.0)	0 (0.0)
Pain	1 (1.9)	0 (0.0)	0 (0.0)
Pyrexia	1 (1.9)	1 (0.3)	1 (0.3)
<b>Infections and Infestations</b>			
Bronchitis	0 (0.0)	2 (0.5)	5 (1.4)
Cellulitis	0 (0.0)	0 (0.0)	4 (1.1)
Gastroenteritis	1 (1.9)	2 (0.5)	0 (0.0)
Herpes simplex	2 (3.8)	0 (0.0)	1 (0.3)
Localised infection	1 (1.9)	1 (0.3)	0 (0.0)
Nasopharyngitis	3 (5.8)	11 (3.0)	9 (2.5)
Pneumonia	1 (1.9)	0 (0.0)	3 (0.8)
Skin bacterial infection	1 (1.9)	0 (0.0)	0 (0.0)
Tooth abscess	1 (1.9)	0 (0.0)	0 (0.0)
Upper respiratory tract infection	3 (5.8)	7 (1.9)	6 (1.6)
Urinary tract infection	0 (0.0)	3 (0.8)	4 (1.1)
Vaginal infection	1 (1.9)	0 (0.0)	0 (0.0)
<b>Musculoskeletal and Connective Tissue Disorders</b>			
Arthralgia	0 (0.0)	5 (1.4)	0 (0.0)
Pain in extremity	1 (1.9)	0 (0.0)	0 (0.0)
<b>Nervous System Disorders</b>			



System Organ Class (SOC)	Adalimumab 40 mg Every other week N = 52 n (%)	Adalimumab 40 mg weekly N = 367 n (%)	Placebo N = 366 n (%)
Dizziness	1 (1.9)	6 (1.6)	1 (0.3)
Dysgeusia	1 (1.9)	2 (0.5)	0 (0.0)
Headache	4 (7.7)	17 (4.6)	11 (3.0)
<b>Respiratory, Thoracic and Mediastinal Disorders</b>			
Cough	0 (0.0)	4 (1.1)	2 (0.5)
Dyspnea	1 (1.9)	1 (0.3)	1 (0.3)
Interstitial lung disease	1 (1.9)	0 (0.0)	0 (0.0)
Nasal congestion	1 (1.9)	0 (0.0)	0 (0.0)
Oropharyngeal pain	1 (1.9)	1 (0.3)	0 (0.0)
Sneezing	1 (1.9)	0 (0.0)	0 (0.0)
<b>Skin and Subcutaneous Tissue Disorders</b>			
Hidradenitis	2 (3.8)	11 (3.0)	16 (4.4)
Pruritus	2 (3.8)	2 (0.5)	1 (0.3)
Pruritus generalised	1 (1.9)	0 (0.0)	0 (0.0)

### Psoriasis

Adalimumab has been studied in 1,696 patients with psoriasis in placebo-controlled and open-label extension studies. The safety profile for patients with psoriasis treated with adalimumab was similar to the safety profile seen in patients with rheumatoid arthritis. Safety results of the long-term open-label study are consistent with the known safety profile of adalimumab in other psoriasis studies. **Table 11** summarizes adverse drug reactions reported at a rate of at least 1% in psoriasis patients treated with an initial dose of adalimumab 80 mg followed by adalimumab 40 mg every other week compared to placebo or methotrexate.

**Table 11. Number and Percentage of Patients ≥ 1% Reporting Treatment-Emergent Adverse Events Possibly or Probably Related to Study Drug in Controlled Psoriasis Studies (Studies M03-656, M04-716 and M02-528)**

System Organ Class (SOC)	Adalimumab 80 mg x 1, then 40 mg s.c. eow N = 966 n (%)	Placebo + MTX N = 613 n (%)
<b>Gastrointestinal Disorders</b>		
Nausea	10 (1.0)	11 (1.8)
<b>General Disorders and Administration Site Conditions</b>		
Injection site reaction	29 (3.0)	9 (1.5)
Injection site irritation	16 (1.7)	6 (1.0)
Injection site pain	14 (1.5)	9 (1.5)
Fatigue	10 (1.0)	5 (0.8)
<b>Infections and Infestations</b>		
Upper respiratory infection	12 (1.2)	3 (0.5)
<b>Musculoskeletal and Connective Tissue Disorders</b>		
Arthralgia	10 (1.0)	3 (0.5)
<b>Nervous System Disorders</b>		
Headache	19 (2.0)	14 (2.3)

Definition(s): s.c. = subcutaneous; eow = every other week; MTX = methotrexate

## Uveitis

Adalimumab has been studied in 500 adult patients with uveitis in two placebo-controlled studies and one open-label extension study. The safety profile for adult patients with uveitis treated with adalimumab was consistent with the known safety profile of adalimumab. Safety results of the long-term open-label study are generally consistent with the known safety profile of adalimumab in the controlled uveitis studies; the exposure-adjusted incidence rates of severe and serious adverse events (including serious infections) were higher in patients who received concomitant systemic corticosteroids and immunosuppressants. **Table 12** summarizes adverse drug reactions reported at a rate of at least 1% in adult patients with uveitis treated with an initial dose of adalimumab 80 mg followed by adalimumab 40 mg every other week compared to placebo.

**Table 12. Number and Percentage of Patients ≥ 1% Reporting Treatment-Emergent Adverse Events Possibly or Probably Related to Study Drug in Controlled Adult Uveitis Studies (Studies M10-877 and M10-880)**

System Organ Class (SOC)	Adalimumab 80 mg x 1, then 40 mg s.c. eow N = 250; n (%)	Placebo N = 250; n (%)
<b>Cardiac Disorders</b>	6 (2.4)	1 (0.4)
Palpitations	4 (1.6)	1 (0.4)
<b>Ear and Labyrinth Disorders</b>	2 (0.8)	4 (1.6)
Tinnitus	1 (0.4)	3 (1.2)
<b>Endocrine Disorders</b>	5 (2.0)	4 (1.6)
Cushingoid	3 (1.2)	3 (1.2)
<b>Eye Disorders</b>	20 (8.0)	20 (8.0)
Cataract	3 (1.2)	4 (1.6)
Cataract subcapsular	3 (1.2)	1 (0.4)
Cystoid Macular Oedema	3 (1.2)	1 (0.4)
Uveitis	3 (1.2)	6 (2.4)
<b>Gastrointestinal Disorders</b>	26 (10.4)	17 (6.8)
Abdominal discomfort	3 (1.2)	1 (0.4)
Abdominal pain upper	4 (1.6)	2 (0.8)
Dry mouth	4 (1.6)	0
Dyspepsia	3 (1.2)	2 (0.8)
Nausea	5 (2.0)	7 (2.8)
<b>General Disorders and Administration Site Conditions</b>	50 (20.0)	38 (15.2)
Fatigue	13 (5.2)	11 (4.4)
Injection site bruising	2 (0.8)	3 (1.2)
Injection site erythema	4 (1.6)	1 (0.4)
Injection site pain	10 (4.0)	12 (4.8)
Injection site rash	6 (2.4)	1 (0.4)
Injection site swelling	4 (1.6)	0
Malaise	2 (0.8)	4 (1.6)
Oedema peripheral	5 (2.0)	3 (1.2)
Peripheral swelling	3 (1.2)	0
Pyrexia	4 (1.6)	2 (0.8)
<b>Infections and Infestations</b>	51 (20.4)	29 (11.6)
Bronchitis	4 (1.6)	3 (1.2)
Influenza	1 (0.4)	3 (1.2)

<b>System Organ Class (SOC)</b>	<b>Adalimumab 80 mg x 1, then 40 mg s.c. eow N = 250; n (%)</b>	<b>Placebo N = 250; n (%)</b>
Nasopharyngitis	14 (5.6)	7 (2.8)
Rash pustular	4 (1.6)	0
Upper respiratory tract infection	7 (2.8)	3 (1.2)
Urinary tract infection	7 (2.8)	5 (2.0)
<b>Investigations</b>	<b>32 (12.8)</b>	<b>18 (7.2)</b>
Alanine aminotransferase increased	8 (3.2)	1 (0.4)
Aspartate aminotransferase increased	7 (2.8)	0
Blood creatinine increased	3 (1.2)	2 (0.8)
Blood pressure increased	4 (1.6)	0
Intraocular pressure increased	5 (2.0)	3 (1.2)
Weight increased	5 (2.0)	2 (0.8)
White blood cell count decreased	3 (1.2)	1 (0.4)
<b>Metabolism and Nutrition Disorders</b>	<b>12 (4.8)</b>	<b>8 (3.2)</b>
<b>Diabetes mellitus</b>	<b>0</b>	<b>4 (1.6)</b>
Increased appetite	1 (0.4)	4 (1.6)
<b>Musculoskeletal and Connective Tissue Disorders</b>	<b>39 (15.6)</b>	<b>30 (12.0)</b>
Arthralgia	14 (5.6)	12 (4.8)
Back pain	3 (1.2)	1 (0.4)
Joint swelling	2 (0.8)	3 (1.2)
Muscle spasms	5 (2.0)	2 (0.8)
Musculoskeletal stiffness	3 (1.2)	2 (0.8)
Myalgia	4 (1.6)	3 (1.2)
Pain in extremity	8 (3.2)	1 (0.4)
<b>Nervous System Disorders</b>	<b>29 (11.6)</b>	<b>16 (6.4)</b>
Dizziness	2 (0.8)	4 (1.6)
Headache	12 (4.8)	12 (4.8)
Paraesthesia	7 (2.8)	1 (0.4)
Tremor	4 (1.6)	1 (0.4)
<b>Psychiatric Disorders</b>	<b>24 (9.6)</b>	<b>10 (4.0)</b>
Anxiety	4 (1.6)	0
Insomnia	13 (5.2)	7 (2.8)
<b>Respiratory, Thoracic and Mediastinal Disorders</b>	<b>18 (7.2)</b>	<b>8 (3.2)</b>
Cough	5 (2.0)	3 (1.2)
Dyspnoea	2 (0.8)	3 (1.2)
<b>Skin and Subcutaneous Tissue Disorders</b>	<b>40 (16.0)</b>	<b>36 (14.4)</b>
Acne	5 (2.0)	7 (2.8)
Alopecia	3 (1.2)	6 (2.4)
Dermatitis allergic	3 (1.2)	2 (0.8)
Eczema	3 (1.2)	1 (0.4)
Erythema	4 (1.6)	3 (1.2)
Hyperhidrosis	6 (2.4)	3 (1.2)
Pruritus	5 (2.0)	1 (0.4)
Rash	3 (1.2)	4 (1.6)
<b>Vascular Disorders</b>	<b>12 (4.8)</b>	<b>10 (4.0)</b>

<b>System Organ Class (SOC)</b>	<b>Adalimumab 80 mg x 1, then 40 mg s.c. eow N = 250; n (%)</b>	<b>Placebo N = 250; n (%)</b>
Hot flush	4 (1.6)	2 (0.8)
Hypertension	4 (1.6)	3 (1.2)

Definition(s): s.c. = subcutaneous; eow = every other week

During the double-masked controlled clinical trials, the most common ( $\geq 5\%$ ) adverse drug reactions in subjects receiving adalimumab were nasopharyngitis (n = 44, 17.6%), arthralgia (n = 38, 15.2%), headache (n = 30, 12.0%), fatigue (n = 26, 10.4%), urinary tract infection (n = 21, 8.4%), uveitis (n = 20, 8.0%), back pain (n = 19, 7.6%), insomnia (n = 18, 7.2%), cough (n = 18, 7.2%), eye pain (n = 18, 7.2%), and upper respiratory tract infection (n = 15, 6.0%).

During the double-masked controlled clinical trials, the most common serious adverse event occurring in >1 patient more often in the adalimumab-treated patients compared to placebo was pneumonia (n = 2). During the overall adalimumab uveitis development program, including the double-masked controlled, and open-label extension trials, the most frequently reported serious adverse event was cataract (n = 7).

During the double-masked controlled clinical trials, severe adverse events reported in >1 patient occurring more often in the adalimumab-treated patients compared to placebo were diarrhea (n = 2) and pneumonia (n = 2). During the overall adalimumab uveitis development program, including the double-masked controlled, and open-label extension trials, the most common severe adverse events reported were pneumonia, urinary tract infection, hypertension and severe vision loss (n = 4 each).

### **Other Common Clinical Trial Adverse Drug Reactions**

Other clinical trial adverse reactions occurring at an incidence of  $\geq 1\%$  that were observed among the various indications include:

Eye Disorders: conjunctivitis, visual impairment

Renal and Urinary Disorders: hematuria, renal impairment

### **9.3 Less Common Clinical Trial Adverse Reactions**

Infrequent serious adverse drug reactions occurring at an incidence of less than 1% in patients treated with adalimumab in RA Studies DE009, DE011, DE019, DE031 and DE013, JIA Study DE038, PsA Studies M02-518 and M02-570, AS Studies M03-607 and M03-606, CD Maintenance Studies M02-404 and M02-433, UC Studies M06-826 and M06-827, HS Studies M10-467, M11-313 and M11-810, Ps Studies M03-656, M04-716, and M02-528, and uveitis Studies M10-877 and M10-880:

Blood and Lymphatic System Disorders: agranulocytosis, anemia, eosinophilia, leukopenia, lymphadenopathy, lymphocytosis, neutropenia, pancytopenia

Cardiac Disorders: arrhythmia supraventricular, cardiac arrest, chest pain,

	palpitations
Eye Disorders:	blepharitis, diplopia, eye swelling
Gastrointestinal Disorders:	abdominal pain, anal fistula, Crohn's disease, frequent bowel movements, hematochezia, hemorrhoidal hemorrhage, pancreatitis, rectal hemorrhage, small intestine obstruction
General Disorders and Administration Site Conditions:	death, non-cardiac chest pain, pyrexia
Hepatobiliary Disorders:	hepatic necrosis
Immune System Disorders:	hypersensitivity
Infections and Infestations:	abscess, abscess limb, arthritis bacterial, bronchitis, bronchopneumonia, cellulitis, cystitis, device-related infection, diverticulitis, erysipelas, escherichia sepsis, gastroenteritis, genital herpes, herpes virus infection, herpes zoster, histoplasmosis, infected skin ulcer, infection, lobar pneumonia, lower respiratory tract infection, meningitis viral, mycobacterium avium complex infection, necrotizing fasciitis, perianal abscess, pharyngitis, pneumonia, pneumonia pneumococcal, pyelonephritis, respiratory tract infection, sepsis, septic shock, sinusitis, tuberculosis, urinary tract infection, urosepsis, viral infection, wound infection
Injury, Poisoning and Procedural Complications:	postoperative wound complication
Investigations:	double-stranded DNA antibody, hepatic enzyme increased
Metabolism and Nutrition Disorders:	hyperglycemia*
Musculoskeletal and Connective Tissue Disorders:	arthritis, arthropathy, back pain, muscular weakness, musculoskeletal chest pain, osteitis, rheumatoid arthritis, systemic lupus erythematosus
Neoplasms Benign, Malignant and Unspecified (Including Cysts and Polyps):	basal cell carcinoma, B-cell lymphoma, breast cancer, malignant melanoma <i>in situ</i> , metastases to liver, ovarian cancer, squamous cell carcinoma, testicular seminoma (pure)
Nervous System Disorders:	clonus, hyperreflexia, hydrocephalus, hypertensive encephalopathy, intention tremor, multiple sclerosis, paresthesia, tremor, neuropathy

Pregnancy, Puerperium and Perinatal Conditions:	abortion spontaneous
Psychiatric Disorders:	confusional state
Renal and Urinary Disorders:	nocturia
Reproductive System and Breast Disorders:	cervical dysplasia, endometrial hyperplasia
Respiratory, Thoracic and Mediastinal Disorders:	bronchospasm, lung infiltration, pleural effusion, pleurisy, pneumonitis, respiratory failure
Skin and Subcutaneous Tissue Disorders:	psoriasis, pustular psoriasis, rash
Surgical and Medical Procedures:	arthrodesis
Vascular Disorders:	circulatory collapse, rheumatoid vasculitis

\*Hyperglycemia ADR in trials were nonserious

#### **9.4 Abnormal Laboratory Findings: Hematologic, Clinical Chemistry and Other Quantitative Data**

There are no known laboratory tests that may be helpful in following the patient's response or in identifying possible adverse reactions.

##### **Pediatric**

In the polyarticular juvenile idiopathic arthritis trial (Study DE038), 10/171 (5.8%) and 5/171 (2.9%) of patients treated with adalimumab developed severe elevations of ALT and aspartate aminotransferase (AST) (exceeding > 3 times the upper limit of normal [ULN] of ALT and AST, respectively). Forty two (42)/171 (25%) developed elevations of creatine phosphokinase (CPK); with 10/171 (5.8%) patients with severe elevations.

Liver enzyme elevations were more frequent among those treated with the combination of adalimumab and MTX than treated with adalimumab alone (ALT: 9.5% vs. 2.3%; AST: 5.9% vs. 0%).

No ALT or AST elevations  $\geq 3 \times$  ULN occurred in the open-label study of adalimumab in patients with polyarticular JIA who were 2 to <4 years of age (Study M10-444).

##### **Adult**

In controlled rheumatoid arthritis clinical trials (Studies DE009, DE011, DE019, and DE031),

elevations of alanine aminotransferase (ALT) were similar in patients receiving adalimumab or placebo. In patients with early rheumatoid arthritis (disease duration of less than three years) (Study DE013), elevations of ALT were more common in the combination arm (adalimumab + methotrexate) compared to the methotrexate monotherapy arm or the adalimumab monotherapy arm.

In psoriatic arthritis clinical trials, elevations in ALT were more common in psoriatic arthritis patients compared with patients in rheumatoid arthritis clinical studies.

In controlled Crohn's disease clinical trials and ulcerative colitis, elevations of ALT were similar in patients receiving adalimumab or placebo.

In all indications, patients with raised ALT were asymptomatic and in most cases, elevations were transient and resolved on continued treatment.

### 9.5 Post-Market Adverse Reactions

The following post-market adverse drug reactions have been reported:

Cardiac Disorders:	myocardial infarction
Gastrointestinal Disorders:	diverticulitis, intestinal perforation, pancreatitis
General disorders and administration site conditions:	pyrexia
Hematologic Events:	thrombocytopenia <sup>†</sup>
Hepatobiliary Disorders:	liver failure, hepatitis, autoimmune hepatitis
Hypersensitivity Reactions:	anaphylaxis <sup>†</sup> , angioedema, angioneurotic edema
Immune System Disorders:	sarcoidosis
Infections:	infections in infants exposed in utero, legionellosis, listeriosis, reactivation of hepatitis B virus (HBV) <sup>†</sup>
Musculoskeletal and Connective Tissue Disorders:	lupus-like syndrome <sup>†*</sup>
Neoplasia:	hepatosplenic T-cell lymphoma (HSTCL) <sup>†</sup> , leukemia <sup>†</sup> , Merkel cell carcinoma (neuroendocrine carcinoma of the skin)
Nervous System Disorders:	cerebrovascular accident, demyelinating disorders (e.g., Guillain-Barré syndrome, optic neuritis)

Skin Reactions:	alopecia, cutaneous vasculitis, erythema multiforme, lichenoid skin reaction**, new onset or worsening of psoriasis (including palmoplantar pustular psoriasis)*, Stevens-Johnson syndrome
Respiratory, Thoracic and Mediastinal Disorders:	interstitial lung disease (including pulmonary fibrosis), pulmonary embolism
Vascular Disorders:	deep vein thrombosis, systemic vasculitis

† See (**WARNINGS AND PRECAUTIONS**)

\* See (**ADVERSE REACTIONS, Adverse Drug Reaction Overview**)

\*\* occurring in patients receiving a TNF-antagonist including adalimumab

## 10 DRUG INTERACTIONS

### 10.1 Serious Drug Interactions Box

#### Serious Drug Interactions

Serious infections and sepsis, including fatalities, have been reported with the use of TNF-blocking agents, including adalimumab. Many of the serious infections have occurred in patients on concomitant immunosuppressive therapy that, in addition to their rheumatoid arthritis, could predispose them to infections. Tuberculosis and invasive opportunistic fungal infections have been observed in patients treated with TNF-blocking agents, including adalimumab.

### 10.2 Overview

Population pharmacokinetic analyses with data from over 1,200 rheumatoid arthritis patients revealed that co-administration of methotrexate had an intrinsic effect on the apparent clearance of adalimumab (CL/F). See (**DRUG INTERACTIONS, Drug-Drug Interactions**). As expected, there was a trend toward higher apparent clearance of adalimumab with increasing body weight and in the presence of anti-adalimumab antibodies.

Other more minor factors were also identified: higher apparent clearance was predicted in rheumatoid arthritis patients receiving doses lower than the recommended dose, and in rheumatoid arthritis patients with high rheumatoid factor or C-reactive protein (CRP) concentrations. These factors are not likely to be clinically important.

Adalimumab has been studied in rheumatoid arthritis patients taking concomitant methotrexate. See (**CLINICAL TRIALS**). The data do not suggest the need for dose adjustment of either adalimumab or methotrexate.



### 10.3 Drug-Drug Interactions

**Table 13. Established or Potential Drug-Drug Interactions**

Concomitant Drug Name	Clinical Comment
Abatacept	Concurrent administration of TNF-blockers and abatacept has been associated with an increased risk of infections including serious infections compared to TNF-blockers alone. This combination has not demonstrated increased clinical benefit. Thus the combined use of TNF-blockers and abatacept is not recommended.
Anakinra	Concurrent administration of anakinra (an interleukin-1 antagonist) and another TNF-blocking agent has been associated with an increased risk of serious infections, an increased risk of neutropenia and no additional benefit compared to these medicinal products alone. Therefore, the combination of anakinra with other TNF-blocking agents, including adalimumab, may also result in similar toxicities. See (WARNINGS AND PRECAUTIONS, General, Concurrent Administration of Biologic DMARDs or TNF-antagonists).
Cytochrome P450 (CYP450) Substrates	The formation of CYP450 enzymes may be suppressed by increased levels of cytokines (e.g., TNF $\alpha$ , IL-6) during chronic inflammation. It is possible for a molecule that antagonizes cytokine activity, such as adalimumab, to influence the formation of CYP450 enzymes. Upon initiation or discontinuation of adalimumab in patients being treated with CYP450 substrates with a narrow therapeutic index, monitoring of the effect (e.g., warfarin) or drug concentration (e.g., cyclosporine or theophylline) is recommended and the individual dose of the drug product may be adjusted as needed.
Methotrexate (MTX)	When adalimumab was administered to 21 rheumatoid arthritis patients on stable MTX therapy, there were no statistically significant changes in the serum MTX concentration profiles. In contrast, after single and multiple dosing, MTX reduced adalimumab apparent clearances by 29 and 44% respectively, in patients with rheumatoid arthritis. See (CLINICAL TRIALS).
Other	Interactions between adalimumab and drugs other than MTX have not been evaluated in formal pharmacokinetic studies. In rheumatoid arthritis clinical trials where adalimumab was co-administered with commonly-used DMARDs (sulfasalazine, hydrochloroquine, leflunomide and parenteral gold), glucocorticoids, salicylates, nonsteroidal antiinflammatory drugs or analgesics, no safety signals were seen. There is no data on other DMARDs, and patients with prior treatment with alkylating agents (e.g., cyclophosphamide) were excluded.

Definition(s): DMARDs = disease-modifying anti-rheumatic drugs; MTX = methotrexate; TNF = tumor necrosis factor

### 10.4 Drug-Food Interactions

HYRIMOZ (adalimumab injection) is administered as a subcutaneous injection. Interactions with food are therefore not applicable.

### 10.5 Drug-Herb Interactions

Interactions with herbal products have not been established.

## 10.6 Drug-Laboratory Test Interactions

There are no known laboratory tests that may be helpful in following the patient's response or in identifying possible adverse reactions.

## 10.7 Drug-Lifestyle Interactions

Adalimumab may have a minor influence on the ability to drive and use machines. Dizziness (including vertigo, vision disorder and fatigue) may occur following administration of adalimumab.

# 11 ACTION AND CLINICAL PHARMACOLOGY

## 11.1 Mechanism of Action

Adalimumab binds specifically to TNF-alpha and blocks its interaction with the p55 and p75 cell surface TNF receptors. Adalimumab also lyses surface TNF-expressing cells in vitro in the presence of complement. Adalimumab does not bind or inactivate lymphotoxin (TNF-beta). TNF is a naturally-occurring cytokine that is involved in normal inflammatory and immune responses. Elevated levels of TNF are found in the synovial fluid of rheumatoid arthritis, including polyarticular JIA, psoriatic arthritis and ankylosing spondylitis patients and play an important role in both pathologic inflammation and joint destruction that are hallmarks of these diseases. Increased levels of TNF are also found in psoriasis plaques, which contribute to the inflammatory response, to the proliferation and decreased maturation of keratinocytes and to the associated vascular damages that are characteristic of the disease. Increased levels of TNF are also found in hidradenitis suppurativa lesions.

Adalimumab also modulates biological responses that are induced or regulated by TNF, including changes in the levels of adhesion molecules responsible for leukocyte migration [ELAM-1, VCAM-1, and ICAM-1 with a half maximal inhibitory concentration (IC<sub>50</sub>) of 1 to 2 x 10<sup>-10</sup>M].

## 11.2 Pharmacodynamics

After treatment with adalimumab, a rapid decrease in levels of acute phase reactants of inflammation [C-reactive protein (CRP) and erythrocyte sedimentation rate (ESR)] and serum cytokines (IL-6) was observed compared to baseline in patients with rheumatoid arthritis. A rapid decrease in CRP levels was also observed in patients with Crohn's disease ulcerative colitis and hidradenitis suppurativa. Serum levels of matrix metalloproteinases (MMP-1 and MMP-3) that produce tissue remodeling responsible for cartilage destruction were also decreased after adalimumab administration.

The serum adalimumab concentration-efficacy relationship as measured by the American College of Rheumatology response criteria (ACR 20) appears to follow the Hill Emax equation as shown in **Figure 1**.

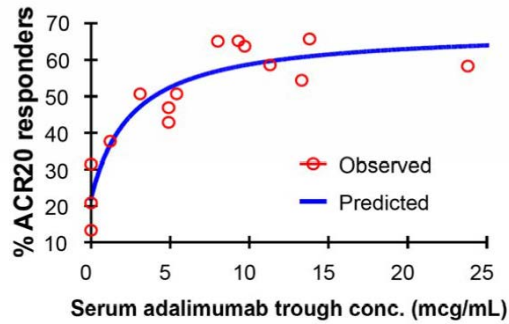

**Figure 1. Serum Adalimumab Concentration-Efficacy Relationship as Measured by the American College of Rheumatology Response Criteria (ACR 20)**

The half maximal effective concentration (EC<sub>50</sub>) estimates ranging from 0.8 to 1.4 mcg/mL were obtained through pharmacokinetic / pharmacodynamic modelling of swollen joint count, tender joint count and ACR 20 response from patients participating in Phase 2 and 3 trials.

### 11.3 Pharmacokinetics

#### Pediatric

Following the administration of 24 mg/m<sup>2</sup> (up to a maximum of 40 mg) subcutaneously every other week to patients with polyarticular JIA who were 4 to 17 years, the mean trough steady-state (values measured from Week 20 to 48) serum adalimumab concentration was 5.5 ± 5.6 mcg/mL (102% CV) adalimumab monotherapy and 10.9 ± 5.2 mcg/mL (47.7% CV) with concomitant MTX. In patients with polyarticular JIA who were 2 to <4 years old or aged 4 and above weighing <15 kg dosed with adalimumab 24 mg/m<sup>2</sup>, the mean trough steady-state serum adalimumab concentrations was 6.0 ± 6.1 mcg/mL (101% CV) adalimumab monotherapy and 7.9 ± 5.6 mcg/mL (71.2% CV) with concomitant MTX.

#### Adult

The single-dose pharmacokinetics of adalimumab in rheumatoid arthritis patients were determined in several studies with intravenous doses ranging from 0.25 to 10.0 mg/kg. The distribution volume (V<sub>ss</sub>) ranged from 4.7 to 6.0 L. The systemic clearance of adalimumab is approximately 12 mL/h. The mean terminal half-life was approximately two weeks, ranging from 10 to 20 days across studies. The pharmacokinetics of adalimumab were linear over the dose range of 0.5 to 10.0 mg/kg following a single intravenous dose.

Adalimumab mean steady-state trough concentrations of approximately 5 mcg/mL and 8 to 9 mcg/mL, were observed in rheumatoid arthritis patients without and with methotrexate, respectively. The serum adalimumab trough levels at steady-state increased approximately proportionally with dose following 20, 40 and 80 mg every other week and every week subcutaneous dosing. In long-term studies with dosing more than two years, there was no evidence of changes in clearance over time.

Population pharmacokinetic analyses in patients with rheumatoid arthritis revealed that there was a trend toward higher apparent clearance of adalimumab in the presence of anti-

adalimumab antibodies.

In patients with psoriatic arthritis, adalimumab mean steady-state trough concentrations of 8.5 to 12 mcg/mL and 6 to 10 mcg/mL were observed in patients with and without methotrexate, respectively.

In patients with Crohn's disease, the loading dose of 160 mg adalimumab on Week 0 followed by 80 mg adalimumab on Week 2 achieves mean serum adalimumab trough concentrations of approximately 12 mcg/mL at Week 2 and Week 4. Mean steady-state trough levels of approximately 7 mcg/mL were observed at Week 24 and Week 56 in Crohn's disease patients who received a maintenance dose of adalimumab 40 mg every other week.

Population pharmacokinetic analysis in patients with Crohn's disease revealed a lower apparent clearance of adalimumab as compared to patients with rheumatoid arthritis.

In patients with ulcerative colitis, a loading dose of 160 mg adalimumab on Week 0 followed by 80 mg adalimumab on Week 2 achieved serum adalimumab trough concentrations of  $11.8 \pm 4.0$  mcg/mL at Week 2 (n=167) and  $12.3 \pm 5.4$  mcg/mL at Week 4 (n=160). At Week 52, trough levels of  $8.0 \pm 6.1$  mcg/mL were observed in UC patients who received a maintenance dose of 40 mg adalimumab every other week (n=101). Trough levels at Week 52 were  $10.8 \pm 7.5$  mcg/mL in UC patients achieving remission (n=39) and  $6.2 \pm 4.2$  mcg/mL in UC patients not achieving remission (n=62).

In patients with HS, a dose of 160 mg adalimumab on Week 0 followed by 80 mg adalimumab on Week 2 achieved serum adalimumab trough concentrations of approximately 7 to 8 mcg/mL at Week 2 and Week 4. The mean steady-state trough concentration at Week 12 through Week 36 were approximately 8 to 10 mcg/mL during adalimumab 40 mg every week treatment.

In patients with psoriasis, the mean steady-state trough concentration was 5 mcg/mL during adalimumab 40 mg every other week monotherapy treatment.

In patients with uveitis, a loading dose of 80 mg adalimumab on Week 0 followed by 40 mg adalimumab every other week starting at Week 1, resulted in mean steady-state concentrations of approximately 8 to 10 mcg/mL.

### **Absorption:**

The maximum serum concentration ( $C_{max}$ ) and the time to reach the maximum concentration ( $T_{max}$ ) were  $4.7 \pm 1.6$  mcg/mL and  $131 \pm 56$  hours respectively, following a single 40 mg subcutaneous administration of adalimumab to healthy adult subjects. The average absolute bioavailability of adalimumab estimated from three studies following a single 40 mg subcutaneous dose was 64%. The pharmacokinetics of adalimumab were linear over the dose range of 0.5 to 10.0 mg/kg following a single intravenous dose.

### **Distribution:**

Adalimumab concentrations in the synovial fluid from five rheumatoid arthritis patients ranged from 31 to 96% of those in serum.

**Metabolism:**

No formal studies have been conducted to evaluate the metabolism of adalimumab. However, as adalimumab is an IgG1 antibody of entirely human sequences, it is expected that its metabolism would follow the course of other IgG molecules.

**Elimination:**

No formal studies have been conducted to evaluate the excretion of adalimumab. However, as adalimumab is an IgG1 antibody of entirely human sequences, it is expected that its excretion would follow the course of other IgG molecules.

**Special Populations and Conditions****Pediatrics:**

Adalimumab has not been studied in pediatric patients with polyarticular JIA less than 2 years of age or in patients with a weight <10 kg.

**Geriatrics:**

Population pharmacokinetic analyses in patients with rheumatoid arthritis revealed that there was a trend toward lower clearance with increasing age in patients aged 40 to > 75 years of age.

**Gender:**

Population pharmacokinetic analyses in patients with rheumatoid arthritis revealed that no gender-related pharmacokinetic differences were observed after correction for a patient's body weight.

**Race:**

No differences in immunoglobulin clearance would be expected among races. From limited data in non-Caucasians, no important kinetic differences were observed for adalimumab.

**Hepatic Insufficiency:**

No pharmacokinetic data are available in patients with hepatic impairment.

**Renal Insufficiency:**

No pharmacokinetic data are available in patients with renal impairment.

**Disease States:**

Healthy volunteers and patients with rheumatoid arthritis displayed similar adalimumab

pharmacokinetics. Population pharmacokinetic analyses predicted minor increases in apparent clearance in patients receiving doses lower than the recommended dose and in patients with high rheumatoid factor or C-reactive protein (CRP) concentrations. These increases are not likely to be clinically important. See (DOSAGE AND ADMINISTRATION, Dosing Considerations, Disease States).

## 12 STORAGE, STABILITY AND DISPOSAL

Do not use beyond the expiration date on the container. HYRIMOZ (adalimumab injection) must be refrigerated at 36°F to 46°F (2°C to 8°C). DO NOT FREEZE. Do not use if frozen even if it has been thawed. Store in original carton until time of administration to protect from light.

If needed, for example when traveling, HYRIMOZ may be stored at room temperature up to a maximum of 77°F (25°C) for a period of up to 21 days, with protection from light. HYRIMOZ should be discarded if not used within the 21-day period. Record the date when HYRIMOZ is first removed from the refrigerator in the spaces provided on the carton.

Do not store HYRIMOZ in extreme heat or cold.

## 13 SPECIAL HANDLING INSTRUCTIONS

A puncture-resistant container for disposal of needles and syringes (including the Pen) should be used. Patients or caregivers should be instructed in the handling technique as well as proper syringe and needle disposal, and be cautioned against reuse of these items.

A healthcare professional (e.g., doctor, nurse or pharmacist) should be consulted for instructions on how to properly dispose of used needles and syringes (including the Pen). Special provincial or local laws regarding the proper disposal of needles and syringes should be followed. Needles or syringes (including the Pen) should **NEVER** be thrown in the household trash or recycling bin.

- Used needles and syringes (including the Pen) should be placed in a container made especially for this purpose (sharps container), or a hard plastic container with a screw-on cap or metal container with a plastic lid labelled “Used Syringes”. Glass or clear plastic containers should not be used.
- The container should always be kept out of the reach of children.
- When the container is about two-thirds full, the cap or lid should be taped down so that it does not come off. The container should be disposed of as instructed by a healthcare professional. **CONTAINERS SHOULD NEVER BE THROWN IN THE HOUSEHOLD TRASH OR RECYCLING BIN.**
- Unless otherwise instructed by a healthcare professional, used alcohol pads (not included in adalimumab carton) may be placed in the trash. Dose trays and covers may be recycled.

## PART II: SCIENTIFIC INFORMATION

### 14 PHARMACEUTICAL INFORMATION

#### Drug Substance

Proper name:	adalimumab
Chemical name:	Not applicable. Adalimumab is not a chemical. It is an immunoglobulin (recombinant human IgG1 monoclonal antibody).
Molecular formula and molecular mass:	Total apparent molecular weight of 148 kilodaltons (kDa), as determined by Q-TOF and SDS-PAGE analysis.
Structural formula:	

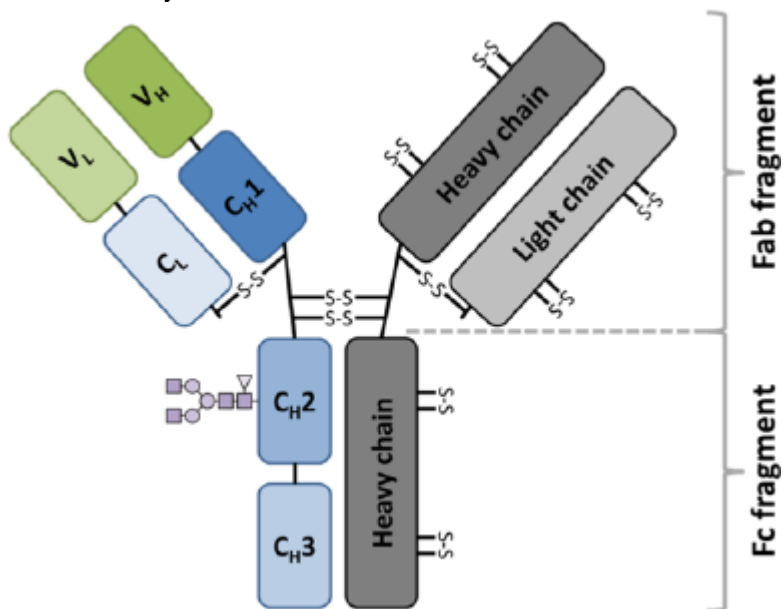

Physicochemical properties:	<p>Adalimumab is an IgG antibody composed of two kappa light chains each with a molecular weight of approximately 23 kDa and two IgG1 heavy chains each with a molecular weight of approximately 51 kDa for a total apparent molecular weight of 148 kDa, as determined by Q-TOF and SDS-PAGE analysis.</p> <p>HYRIMOZ is supplied as a sterile, preservative-free solution for subcutaneous administration. The solution of adalimumab is clear and colourless, with a pH of 5.2</p>
-----------------------------	---

### **Product Characteristics**

HYRIMOZ (adalimumab injection) is a recombinant human immunoglobulin (IgG1) monoclonal antibody specific for human tumor necrosis factor (TNF). Adalimumab was created using phage display technology resulting in an antibody with human derived heavy and light chain variable regions and human IgG1:k constant regions.

Adalimumab is produced by recombinant DNA technology in a mammalian cell expression system and is purified by a process that includes specific viral inactivation and removal steps. It consists of 1330 amino acids and has a molecular weight of approximately 148 kDa.

## **15 COMPARATIVE CLINICAL TRIALS**

### **15.1 Comparative Trial Design and Study Demographics**

Clinical studies conducted to support similarity between HYRIMOZ (adalimumab injection) and the reference biologic drug included:

- A comparative pharmacokinetic (PK) clinical Phase I study in healthy male subjects comparing HYRIMOZ<sup>®</sup> with EU-Humira and EU-Humira with US-Humira (GP17-104).
- A comparative efficacy and safety clinical Phase III in patients with chronic plaque-type psoriasis comparing HYRIMOZ<sup>®</sup> with Humira (GP17-301).

An overview of the study design(s) and demographic characteristics of patients enrolled in each clinical study are presented in **Table 14**.



**Table 14 Summary of trial design**

Study #	Trial design	Dosage, route of administration and duration	Study subjects (n)	Mean age (range)	Sex
<p>GP17-104 <b>(pivotal PK study)</b></p>	<p>Single-center, randomized, double-blind, single-dose, three-arm, parallel-group study</p> <p>Objective: To demonstrate PK comparability for Hyrimoz and EU-Humira, and for EU-Humira and US-Humira after a single s.c. injection of 40 mg of adalimumab</p>	<p>Hyrimoz: 40 mg/0.8 mL, PFS, single s.c. injection</p> <p>EU-Humira: 40 mg/0.8 mL, PFS, single s.c. injection</p> <p>US-Humira: 40 mg/0.8 mL, PFS, single s.c. injection</p>	<p>Healthy male subjects</p>	<p>Overall study population: 37.2 years (18 – 55 years)</p> <p>Hyrimoz: 37.6 years (21 – 55 years)</p> <p>EU-Humira: 36.5 years (19 – 55 years)</p> <p>US-Humira: 37.5 years (18 – 55 years)</p>	<p>Male; N=318m</p> <p>Hyrimoz: N=107m</p> <p>EU-Humira: N=106m</p> <p>US-Humira: N=105m</p>
<p>GP17-301 <b>(pivotal comparative efficacy and safety study)</b></p>	<p>Multi-center, randomized, double-blind, comparator-controlled study with treatment switches</p>	<p>Hyrimoz: 40 mg/0.8 mL, PFS</p> <p>EU-Humira: 40 mg/0.8 mL, PFS</p> <p>US-Humira: 40 mg/0.8 mL, PFS</p> <p>Hyrimoz and Humira were administered as s.c. injections with a loading dose of 80 mg on Day 1 and 40 mg every other week starting with Week 1 and up to Week 49</p>	<p>Male and female patients with moderate to severe chronic plaque-type psoriasis</p>	<p>Overall study population: 46.3 years (18 – 84 years)</p> <p>Hyrimoz: 45.6 years (18 – 81 years)</p> <p>Humira: 46.9 years (18 – 84 years)</p> <p>US-Humira: 46.9 years (19 – 84 years)</p> <p>EU-Humira: 46.9 years (18 – 79 years)</p>	<p>Male and female; N=465 (284m, 181f)</p> <p>Hyrimoz: N=231 (142m, 89f)</p> <p>EU-Humira: N=44 (28m, 16f)</p> <p>US-Humira: N=190 (114m, 76f)</p>

## 15.2 Comparative Study Results

### 15.2.1 Comparative Bioavailability Studies

#### 15.2.1.1 Pharmacokinetics

##### *Comparative Pharmacokinetic Study GP17-104*

**Table 15** Study GP17-104: Statistical analysis of primary pharmacokinetic parameters for the comparison of Hyrimoz with EU-Humira

Adalimumab injection (1 x 40 mg) From measured data				
Geometric Mean Arithmetic Mean (CV %)				
Parameter	Hyrimoz <sup>2</sup>	EU-Humira <sup>3</sup>	% Ratio of Geometric Means <sup>4</sup>	90% Confidence Interval
AUC <sub>T</sub> (mcg•h/mL)	2261 2489 (42.0)	2163 2326 (37.5)	104.6	94.7 – 115.4
AUC <sub>i</sub> (mcg•h/mL)	2728 2952 (41.5)	2557 2719 (35.1)	106.7	97.6 – 116.6
C <sub>MAX</sub> (mcg/mL)	3.67 3.84 (29.0)	3.54 3.70 (29.9)	103.8	96.7 – 111.5
T <sub>MAX</sub> (h) <sup>1</sup>	167.6 (40.1)	154.4 (50.4)	n.a.	n.a.
T <sub>½</sub> (h) <sup>1</sup>	405.6 (45.5)	404.0 (41.4)	n.a.	n.a.

<sup>1</sup> Expressed as the arithmetic mean (CV%) only.

<sup>2</sup> n=104 for AUC<sub>T</sub>, C<sub>MAX</sub>, and T<sub>MAX</sub>; n = 99 for AUC<sub>i</sub> and T<sub>1/2</sub>

<sup>3</sup> n=103 for AUC<sub>T</sub>, C<sub>MAX</sub>, and T<sub>MAX</sub>; n = 101 for AUC<sub>i</sub> and T<sub>1/2</sub>

<sup>4</sup> Least square mean, estimated using analysis of variance with treatment as fixed effect.

### 15.2.2 Comparative Safety and Efficacy

#### 15.2.2.1 Efficacy

##### *Study GP17-301 (Chronic plaque type psoriasis)*

The efficacy and safety of HYRIMOZ has been demonstrated in a multi-center, randomized, double-blind study (GP17-301) in which 465 patients with moderate to severe chronic plaque-type psoriasis were randomized 1:1 to HYRIMOZ or HUMIRA. The study was designed to rule out any clinically meaningful difference between HYRIMOZ and HUMIRA.

The patient population studied in study GP17-301 consisted of adult male and female patients with active, but clinically stable chronic plaque-type skin psoriasis involving a body surface area (BSA) of at least 10%, a minimal PASI of 12 (indicating moderate-to-severe psoriasis),

and an investigator global assessment (IGA) of at least moderate severity (score  $\geq 3$ ). Eligible patients had to have previously received at least one phototherapy or systemic therapy for psoriasis or were candidates to receive such therapy in the opinion of the investigator. Randomization at baseline was stratified by body weight (<90kg and  $\geq 90$ kg), by prior systemic psoriasis therapy and by region (EU and US).

The primary efficacy endpoint was the PASI75 (defined as a 75% reduction of the Psoriasis Area Severity Index)\* response rate measured at Week 16.

The 95% CI of the adjusted treatment difference remained within the predefined equivalence margin of [-18%, 18%].

**Table 16**

Treatment	N	n	Adjusted response rate <sup>1</sup> (SE) [%]	Adjusted response rate difference (SE) [%]	95% CI	Equivalence interval
HYRIMOZ	231	134	58.1 (3.23)	2.2 (4.56)	[-6.79, 11.10]	[-18%, 18%]
HUMIRA	234	131	55.9 (3.23)			

CI=confidence intervals; N=number of patients per treatment group; n=number of patients per treatment group achieving PASI75 response; PASI=psoriasis area and severity index; SE=standard error.

<sup>1</sup> Adjusted response rates were estimated using a logistic regression model including treatment, body weight strata, region and prior systemic therapy. The 95% CI for the rate difference was derived based on the normal approximation and standard error computed using the delta method (method details and code were adopted from Ge et al 2011).

Patients with missing PASI scores at Week 16 regardless of reason (e.g. missing visit, early discontinuation) are considered non-responders for the analysis.

**Table 17 Adjusted treatment difference with US-HUMIRA**

Treatment	N	n	Adjusted response rate <sup>1</sup> (SE) [%]	Adjusted response rate difference (SE) [%]	95% CI	Equivalence interval
HYRIMOZ	231	134	58.1 (3.23)	5.1 (4.85)	[-4.39, 14.61]	[-18%, 18%]
US-HUMIRA	190	101	53.0 (3.61)			

CI=confidence intervals; N=number of patients per treatment group; n=number of patients per treatment group achieving PASI75 response; PASI=psoriasis area and severity index; SE=standard error.

<sup>1</sup> Adjusted response rates were estimated using a logistic regression model including treatment, body weight strata, region and prior systemic therapy. The 95% CI for the rate difference was derived based on the normal approximation and standard error computed using the delta method (method details and code were adopted from Ge et al 2011).

Patients with missing PASI scores at Week 16 regardless of reason (e.g. missing visit, early discontinuation) are considered non-responders for the analysis.

The 95% CI of the adjusted treatment difference for both HUMIRA and US-HUMIRA remained within the predefined equivalence margin of [-18%, 18%].

### 15.2.2.2 Safety

The types, frequency and severity of adverse events were comparable between the biosimilar and the reference biologic drug.

### 15.2.2.3 Immunogenicity

The numbers and proportions of patients with positive ADA responses were similar between the HYRIMOZ and the reference medicine groups during TP1 and during the entire study in the continued treatment groups; NABs were detected in similar proportions between groups.

**Table 18 Summary of patients with confirmed positive ADA response by treatment group – study GP17-301 – Randomization to Week 17 (SAF)**

	<b>HYRIMOZ N=231</b>	<b>reference medicine N=234</b>
<b>ADA response, overall from Week 1<sup>a</sup></b>	<b>n/N' (%)</b>	<b>n/N' (%)</b>
Negative	139/220 (63.2)	145/220 (65.9)
Positive	81/220 (36.8)	75/220 (34.1)
Neutralizing	65/81 (80.2)	60/75 (80.0)

ADA=anti-drug antibody; n=number of patients per treatment group with ADA response; N'=number of patients with evaluable data; N=number of randomized patients; SAF=safety analysis set

<sup>a</sup> Overall from Week 1' indicates that patients had at least one ADA positive result (recorded as positive) or had consistently negative results (recorded as negative) post-baseline.

**Table 19 Summary of patients with confirmed positive ADA response during the entire study by continued group – study GP17-301 – Randomization to Week 51 (SAF)**

	<b>Continued HYRIMOZ N=168</b>	<b>Continued reference medicine N=171</b>
<b>ADA response, overall from Week 1<sup>a</sup></b>	<b>n/N' (%)</b>	<b>n/N' (%)</b>
Negative	98/160 (61.3)	87/159 (54.7)
Positive	62/160 (38.8)	72/159 (45.3)
Neutralizing	55/62 (88.7)	61/72 (84.7)

Continued groups include patients who continued the same treatment throughout the study.

ADA=anti-drug antibody; n=number of patients per treatment group with ADA response; N'=number of patients with evaluable data; N=number of randomized patients; SAF=safety analysis set

<sup>a</sup> Overall from Week 1' indicates that patients had at least one ADA positive result (recorded as positive) or had consistently negative results (recorded as negative) post-baseline.

## 16 COMPARATIVE NON-CLINICAL PHARMACOLOGY AND TOXICOLOGY

### 16.1 Comparative Non-Clinical Pharmacodynamics

The pharmacodynamic response to HYRIMOZ (adalimumab injection) (also referred to as GP2017) and reference adalimumab (EU-HUMIRA and/or US-HUMIRA) was compared in *in vitro* and *in vivo* studies.

### ***In vitro and In vivo Studies***

Pharmacodynamic comparability between GP2017 and reference adalimumab was demonstrated in *in vitro* studies as well as in *in vivo* studies using transgenic mouse models of polyarthritis (Tg197 and Tg5453).

The *in vitro* assays assessed functional characteristics of GP2017 compared to those of reference adalimumab. The results of these assays demonstrated comparable binding to TNF $\alpha$ , C1q and Fc receptors (Fc $\gamma$ RIa, Fc $\gamma$ RIIa, Fc $\gamma$ RIIb/c, Fc $\gamma$ RIIIa –F158 variant, Fc $\gamma$ RIIIb and FcRn) and no off-target binding to other cytokines. Other cell-based assays such as competitive binding to transmembrane TNF $\alpha$ , antibody dependent cell-mediated cytotoxicity (ADCC), complement dependent cytotoxicity (CDC) and apoptosis also demonstrated similarity between GP2017 and reference adalimumab.

Two *in vivo* studies were conducted using transgenic mouse models of arthritis. One study was conducted in Tg5453 transgenic mice in which animals over-express a mutated and bioactive transmembrane human TNF $\alpha$  protein, and the other was conducted in Tg197 transgenic mice in which animals over-express a bioactive soluble human TNF $\alpha$  protein. In these studies, both GP2017 and reference adalimumab produced reductions in arthritic and histopathological scores compared to vehicle-treated mice. In Tg197 mice, these reductions were similar between GP2017 and reference adalimumab. While the reductions were less with GP2017 administration than with reference adalimumab in Tg5453 mice, more sensitive *in vitro* assays demonstrated comparable activity between GP2017 and reference adalimumab on both the soluble and membrane-bound forms of human TNF $\alpha$ . Overall, the results of the *in vivo* studies support the *in vitro* study results.

## **16.2 Comparative Non-Clinical Toxicology**

### **Pivotal comparative toxicity study in monkeys GP17-002**

The safety of GP2017 in comparison to the reference adalimumab (EU-HUMIRA) was assessed in a repeated dose general toxicology study in cynomolgus monkeys, a species in which adalimumab is pharmacologically active. Animals were dosed weekly for four weeks with 100 mg/kg adalimumab administered subcutaneously (s.c.) for a total of five doses. Toxicokinetic assessments confirmed that the animals were exposed to appropriate systemic levels of adalimumab. Assessment of anti-drug antibodies suggested that they did not affect adalimumab exposure over the duration of the study.

Both preparations were well tolerated with no test article-related deaths or clinical signs or effects on body weight, ophthalmoscopy, body temperature, heart rate or ECG, blood pressure, clinical pathology or organ weights. The main test article-related findings in this study were local skin reactions at the injection sites of animals given GP2017 or reference adalimumab when compared to controls. GP2017 and reference adalimumab-administrated animals showed similarity in terms of local tolerance in that both presented with inflammatory lesions at the injection sites. Except for the injection site reactions, there were no macroscopic or microscopic findings directly attributable to effects of adalimumab including in the lymph nodes (i.e. axillary, inguinal, mandibular and mesenteric) assessed in this study.

In summary, a similar safety profile was established for GP2017 and reference adalimumab in cynomolgus monkeys with no systemic adverse effects and no new toxicities identified for GP2017 compared to reference adalimumab.

Comparative local tolerance study in rabbits GP17-008

GP2017 drug product has a different formulation from reference adalimumab (EU-HUMIRA) and so a comparison of local tolerability by both intended (s.c.) and unintended routes of administration was performed in the rabbit. Injections of GP2017 in the commercial formulation using a 27G needle were compared with injections of reference adalimumab using both 27G and 29G needles. Injections were performed at s.c., intra-arterial (i.a.), intra-venous (i.v.) and para-venous (p.v.) sites (0.8 mL/injection) and also intramuscular (i.m.) sites (0.5 mL/injection). GP2017 administered in the commercial formulation was shown to be well tolerated with no test article-related macroscopic or histopathological changes observed at the s.c., i.a., i.v., p.v. and i.m. injection sites and at the draining lymph nodes. Tolerability was similar to that of the reference adalimumab.

**17 CLINICAL TRIALS – REFERENCE BIOLOGIC DRUG**

**Adult**

Rheumatoid Arthritis

**Study Demographics and Trial Design**

The efficacy and safety of adalimumab were assessed in five randomized, double-blind studies in patients ≥ 18 years of age with active rheumatoid arthritis diagnosed according to the American College of Rheumatology (ACR) criteria. Patients had at least six swollen and nine tender joints. Adalimumab was administered subcutaneously in combination with methotrexate (12.5 to 25 mg, Studies DE009, DE019 and DE013), or as monotherapy (Studies DE011 and DE013), or with other disease-modifying anti-rheumatic drugs (DMARDs) (Study DE031).

**Table 20** summarizes the controlled clinical trials that were done in patients with active rheumatoid arthritis.

**Table 20 Summary of Controlled Clinical Trials Supporting Safety and Efficacy in Patients with Rheumatoid Arthritis**

Study #	Trial Design	Dosage, Route of Administration and Duration	Study Subjects (n)	Mean age (Range)	Gender (% Female)
DE009 (RA I)	Multicenter, double-blind, randomized, placebo-controlled	Adalimumab 20 mg, 40 mg, or 80 mg; eow	200	54.8 ± 11.9	75.5
		Placebo Subcutaneous 24 weeks	60	55.2 ± 10.9	83.3
DE011 (RA II)	Multicenter, double-blind, randomized,	Adalimumab 20 mg, 40 mg; ew or eow	434	53.0 ± 12.3	77.4
		Placebo	110	53.5 ± 13.2	77.3

Study #	Trial Design	Dosage, Route of Administration and Duration	Study Subjects (n)	Mean age (Range)	Gender (% Female)
	placebo-controlled	Subcutaneous 26 weeks			
DE019 (RA III)	Multicenter, double-blind, randomized, placebo-controlled	Adalimumab 20 mg ew or 40 mg eow	419	56.2 ± 12.1	75.9
		Placebo Subcutaneous 52 weeks	200	55.6 ± 12.0	73.0
	Open-label extension	Adalimumab 40 mg eow up to 10 years	457	55.7 ± 12.02	74.7
DE031 (RA IV)	Multicenter, double-blind, randomized, placebo-controlled	Adalimumab 40 mg eow	315	55.2 ± 12.7	80.0
		Placebo Subcutaneous 24 weeks	315	55.7 ± 12.4	79.7
DE009, DE011, DE019, DE031 Combined	Multicenter, double-blind, randomized, placebo-controlled	Adalimumab Placebo	1368 685	54.7 ± 12.3 55.3 ± 12.3	77.3 77.7
DE013 (RA V)	Phase 3, multicenter, double-blind, active comparator-controlled, parallel-group	Adalimumab 40 mg eow	274	52.1 ± 13.5	77.4
		Adalimumab 40 mg eow + MTX ew	268	51.9 ± 14.0	72.0
		MTX ew Subcutaneous and oral 104 weeks	257	52.0 ± 13.1	73.9
Definition(s): ew = every week; eow = every other week; MTX = methotrexate					

Mean ages across the four studies ranged from 53.0 years (adalimumab group, Study DE011) to 56.2 years (adalimumab group, Study DE019). The mean age in Study DE013 was 51.9 years (adalimumab + methotrexate group) to 52.0 years (methotrexate group). Mean weight ranged from 68.5 kg (adalimumab group, Study DE011) to 80.3 kg (placebo group, Study DE019). The mean weight in Study DE013 was 74.4 kg (adalimumab group) to 76.8 kg (Adalimumab + methotrexate group). As expected, based on the demographics of the disease, patients were predominantly female, with the percentage of female patients ranging from 73.0% (placebo group, Study DE019) to 83.3% (placebo group, Study DE009). Similarly, the percentage of females in Study DE013 ranged from 72.0% (adalimumab + methotrexate group) to 77.4% (adalimumab group). Patients were predominantly Caucasian, with the percentage of Caucasian patients ranging from 75.0% (placebo group, Study DE009) to 99.1% (placebo group, Study DE011). The percentage of Caucasian patients in Study DE013 ranged from 93.3% (adalimumab + methotrexate group) to 94.2% (methotrexate group). The high percentage of Caucasian patients in Study DE011 was consistent with the populations of the geographic regions in which this study was conducted (i.e., Europe, Canada, and Australia). Overall, the demographic characteristics of the study patients were fairly representative of rheumatoid arthritis in the general population. There were no notable differences between the studies in any of the demographic characteristics analyzed.

## **Description of Clinical Studies**

Adalimumab was evaluated in over 3,000 patients in all rheumatoid arthritis clinical trials. Some patients were treated for up to 10 years. The efficacy and safety of adalimumab were assessed in five randomized, double-blind, well-controlled studies.

Study DE009 evaluated 271 patients with moderately to severely active rheumatoid arthritis who had failed therapy with at least one but no more than four DMARDs, and had inadequate response to methotrexate.

Study DE011 evaluated 544 patients with moderately to severely active rheumatoid arthritis who had failed therapy with at least one DMARD. Doses of placebo, 20 or 40 mg of adalimumab were given by subcutaneous injection as monotherapy every other week or weekly for 26 weeks.

Study DE019 evaluated 619 patients with moderately to severely active rheumatoid arthritis who had an inadequate response to methotrexate. Patients received placebo, 40 mg of adalimumab every other week with placebo injections on alternate weeks, or 20 mg of adalimumab weekly for up to Week 52. Study DE019 had an additional primary endpoint at Week 52 of inhibition of disease progression (as detected by X-ray results). Upon completion of the first 52 weeks, 457 patients enrolled in an open-label extension phase in which 40 mg of adalimumab was administered every other week for up to ten years. 202 patients completed 10 years of the study; the efficacy demonstrated at 5 years (reduction in signs and symptoms of RA, improvement in physical function, inhibition of structural joint damage, and rates of clinical response including remission) was maintained through 10 years with continued adalimumab in these patients. For efficacy results in these patients, see (**CLINICAL TRIALS, Adult, Rheumatoid Arthritis, Study Results, Clinical Response, Studies DE009, DE011 and DE019; Radiographic Response; and Quality of Life and Physical Function Response**). For a description of safety in these patients, see (ADVERSE REACTIONS, Adverse Drug Reaction Overview).

Study DE031 assessed safety in 636 patients with moderately to severely active rheumatoid arthritis who were either DMARD- naïve or were permitted to remain on their pre-existing rheumatologic therapy provided that therapy was stable for a minimum of 28 days. Patients were randomized to 40 mg of adalimumab or placebo every other week for 24 weeks.

Study DE013 evaluated 799 patients with moderate to severely active early rheumatoid arthritis (disease duration less than three years) who were  $\geq 18$  years old and methotrexate naïve. This study compared the efficacy of adalimumab + methotrexate combination therapy and methotrexate monotherapy in reducing the signs and symptoms and rate of progression of joint damage in rheumatoid arthritis. Patients were randomized to receive adalimumab 40 mg every other week + methotrexate combination therapy, adalimumab 40 mg every other week monotherapy, or methotrexate given weekly, for 104 weeks.

## **Study Results**

### **Clinical Response**



Studies DE009, DE011 and DE019

The percent of adalimumab-treated patients achieving ACR 20/50/70 responses was consistent across all three trials. The results of the three trials are summarized in **Table 21**.

**Table 21 ACR Responses in Placebo-Controlled Trials (Percent of Patients)**

Response		Study DE009*		Study DE011*			Study DE019*	
		Placebo + MTX (N=60)	Adalimumab 40 mg eow MTX (N=63)	Placebo (N=100)	Adalimumab 40 mg eow (N=113)	Adalimumab 40 mg ew N = 103	Placebo + MTX (N=200)	Adalimumab 40 mg eow + MTX N = 207
ACR 20	6 months	13.3%	65.1%**	19.1%	46.0%**	53.4%**	29.5%	63.3%**
	12 months	NA	NA	NA	NA	NA	24.0%	58.9%**
ACR 50	6 months	6.7%	52.4%**	8.2%	22.1%**	35.0%**	9.5%	39.1%**
	12 months	NA	NA	NA	NA	NA	9.5%	41.5%**
ACR 70	6 months	3.3%	23.8%**	1.8%	12.4%*	18.4%**	2.5%	20.8%**
	12 months	NA	NA	NA	NA*	NA	4.5%	23.2%**

\* Study DE009 at Week 24, Study DE011 at Week 26, and Study DE019 at Weeks 24 and 52  
 \*\* p < 0.01 for adalimumab versus placebo  
 Definition(s): MTX = methotrexate; ACR = American College of Rheumatology

The results of the components of the ACR response criteria for Studies DE011 and DE019 are shown in **Table 22**. ACR response rates and improvement in all components of ACR response were maintained to Week 104. Over the two years in Study DE019, 24% of adalimumab patients receiving 40 mg every other week achieved a major clinical response, defined as maintenance of an ACR 70 response over a 6-month period. ACR responses were maintained in similar proportions of patients for up to five years with continuous adalimumab treatment in the open-label portion of Study DE019.

**Table 22. Components of ACR Response in Studies DE011 and DE019**

Parameter (median)	Study DE011				Study DE019					
	Placebo N = 110		Adalimumab 40 mg eow N = 103		Placebo + MTX N = 200			Adalimumab 40 mg eow N = 103		
	Baseline	Week 26	Baseline	Week 26	Baseline	Week 24	Week 52	Baseline	Week 24	Week 52
Number of tender joints (Scale 0 to 68)	35	26	31	16*	26	15	15	24	8.0*	6.0*
Number of swollen joints (Scale 0 to 66)	19	16	18	10*	17	11	11	18	5.0*	4.0*
Physician global assessment disease activity†	7	6.1	6.6	3.7*	6.3	3.5	3.8	6.5	2.0*	1.6*
Patient global assessment disease activity†	7.5	6.3	7.5	4.5*	5.4	3.9	4.3	5.2	2.0*	1.8*
Pain†	7.3	6.1	7.3	4.1*	6	3.8	4.6	5.8	2.1*	1.9*
Disability index (HAQ)‡	2	1.9	1.9	1.5*	1.5	1.25	1.25	1.5	0.75*	0.75*
CRP (mg/dL)	3.9	4.3	4.6	1.8*	1	0.9	0.9	1	0.40*	0.40*

† Visual analogue scale; 0 = best; 10 = worst  
‡ Disability index of the Health Assessment Questionnaire (HAQ); 0 = best; 3 = worst, measures the patient's ability to perform the following: dress/groom, arise, eat, walk, reach, grip, maintain hygiene, and maintain daily activity  
\* p < 0.001 for Adalimumab versus placebo, based on mean change from baseline  
Definition(s): MTX = methotrexate; CRP = C-reactive protein

The time course of ACR 20 response for Study DE019 is shown in **Figure 2**. In Study DE019, 85% of patients with ACR 20 responses at Week 24 maintained the response at Week 52. The time course of ACR 20 response for Studies DE009 and DE011 were similar.

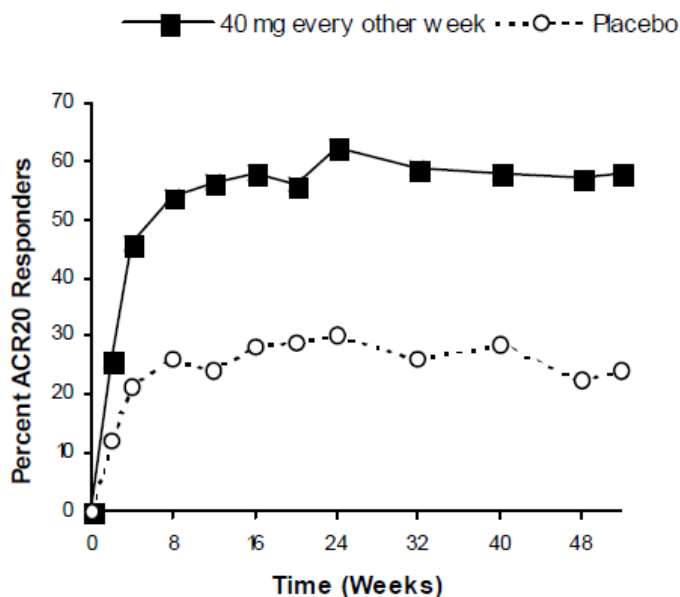

**Figure 2. Study DE019 ACR 20 Responses Over 52 Weeks**

In the open-label extension for Study DE019, durable and sustained ACR 20, 50 and 70 responses have been observed through 5 and 10 years. Of 207 patients, 114 patients continued on adalimumab 40 mg every other week for 5 years. Among those, 86 patients (75.4%) had ACR 20 responses; 72 patients (63.2%) had ACR 50 responses; and 41 patients (36%) had ACR 70 responses. Of 207 patients, 81 patients continued on adalimumab 40 mg every other week for 10 years. Among those, 64 patients (79.0%) had ACR 20 responses; 56 patients (69.1%) had ACR 50 responses; and 43 patients (53.1%) had ACR 70 responses.

### Study DE031

In Study DE031, 53% of patients treated with adalimumab 40 mg every other week plus standard of care had an ACR 20 response at Week 24 compared to 35% on placebo plus standard of care ( $p < 0.001$ ). No unique adverse reactions related to the combination of adalimumab and other DMARDs were observed.

In all four studies, adalimumab-treated patients achieved ACR 20/50/70 responses faster and more often than placebo-treated patients. In Study DE009, there was a statistically significant difference in ACR 20 responses at Week 1 (first study visit) between patients treated with Adalimumab (26.0%) and placebo (5.0%). Statistically significant differences in ACR 20 responses were also seen in Studies DE011, DE019 and DE031 at Week 2 (first study visit) between patients treated with adalimumab (36.4, 29.1 and 33.7%, respectively) and placebo (7.3, 13.0 and 8.6%, respectively). A similar pattern of the time to first ACR 50 and 70 responses was noted in all four studies.

### Study DE013

In Study DE013, for early rheumatoid arthritis patients who were methotrexate naïve, the combination therapy with adalimumab + methotrexate led to faster and significantly greater ACR responses than methotrexate monotherapy at Week 52, and responses were sustained at Week 104. The clinical responses for Study DE013 are presented in **Table 23**.

At Week 52, all individual components of the ACR response criteria improved with adalimumab + methotrexate therapy, and improvements were maintained to Week 104.

Over the two-year study, 48.5% of patients who received adalimumab + methotrexate combination therapy achieved a major clinical response (ACR 70 for six continuous months) compared to 27.2% of patients who received methotrexate monotherapy ( $p < 0.001$ ).

**Table 23. Clinical Responses in Study DE013 (All Randomized Subjects)**

Response		MTX <sup>a</sup> N = 257 (%)	Adalimumab N = 274 (%)	Adalimumab + MTX N = 268 (%)
ACR 20	Week 52	62.6	54.4	72.8
	Week 104	56.0	49.3	69.4
ACR 50	Week 52	45.9	41.2	61.6
	Week 104	42.8	36.9	59.0
ACR 70	Week 52	27.2	25.9	45.5
	Week 104	28.4	28.1	46.6
Major Clinical Response <sup>c</sup>		27.2	24.5	48.5

a.  $p < 0.05$  for Adalimumab + MTX versus MTX for ACR 20

$p < 0.001$  for Adalimumab + MTX versus MTX for ACR 50 and 70 and Major Clinical Response

b.  $p < 0.001$  for Adalimumab + MTX versus Adalimumab

c. Major Clinical Response is achieving ACR 70 response for a continuous six-month period

Definition(s): MTX = methotrexate; ACR = American College of Rheumatology

At Week 52 and Week 104 of treatment in Study DE013, adalimumab + methotrexate combination therapy was superior to methotrexate monotherapy in achieving a low disease state in patients with recently diagnosed moderate to severe rheumatoid arthritis, as demonstrated by the number of patients who achieved clinical remission [disease activity score (DAS28)  $< 2.6$ ] at Week 52 and change from baseline in DAS28 at Week 52 and Week 104.

DAS28 responses for Study DE013 are presented in **Table 24**.

**Table 24. Change in DAS28 from Baseline at Weeks 52 and 104 in Study DE013 (All Randomized Subjects)**

DAS28		MTX N = 257	Adalimumab N = 274	Adalimumab + MTX N = 268
Week 52	n	184	185	206
	Baseline (mean)	6.3	6.4	6.3
	Change at Week 52 (mean $\pm$ SD)	-2.8 $\pm$ 1.4 <sup>a</sup>	-2.8 $\pm$ 1.5 <sup>b</sup>	-3.6 $\pm$ 1.3
	% of subjects in remission (DAS28 $< 2.6$ ) at Week 52	20.6% <sup>a</sup>	23.4% <sup>b</sup>	42.9%
Week	n	161	158	191

DAS28		MTX N = 257	Adalimumab N = 274	Adalimumab + MTX N = 268
104	Baseline (mean)	6.3	6.3	6.3
	Change at Week 104 (mean ± SD)	-3.1 ± 1.4 <sup>a</sup>	-3.2 ± 1.4 <sup>b</sup>	-3.8 ± 1.3
	% of subjects in remission (DAS28 < 2.6) at Week 104	24.9%	25.2%	49.3%

a. p < 0.001 for adalimumab + MTX versus MTX

b. p < 0.001 for adalimumab + MTX versus adalimumab

Definition(s): MTX = methotrexate; DAS = disease activity score; SD = standard deviation

### **Radiographic Response**

In Study DE019, where adalimumab-treated patients had a mean duration of rheumatoid arthritis of approximately 11 years, structural joint damage was assessed radiographically and expressed as change in total Sharp score (TSS) and its components, the erosion score and joint space narrowing (JSN) score at Month 12 compared to baseline. At baseline, the median TSS was approximately 55 in the placebo and 40 mg every other week groups. The 12-month results are shown in **Table 25**. Adalimumab + methotrexate-treated patients demonstrated less radiographic progression than patients receiving methotrexate alone at Week 52.

**Table 25. Radiographic Mean Changes Over 12 Months in Study DE019 with Background Methotrexate**

LOCF	Placebo + MTX N = 200	Adalimumab <sup>a</sup> + MTX N = 207	Adalimumab <sup>a</sup> + MTX and Placebo + MTX (95% CI <sup>**</sup> )	p-value
Change in Modified Total Sharp Score (Mean)	2.7	0.1	-2.6 (1.4, 3.8)	< 0.001*
Change in Erosions (Mean)	1.6	0	-1.6 (0.9, 2.2)	< 0.001
Change in JSN Score (Mean)	1	0.1	-0.9 (0.3, 1.4)	0.002

a. 40 mg administered every other week

\* Based on analysis of ranked ANCOVA

\*\* 95% confidence intervals for the differences in change scores between MTX and adalimumab

Definition(s): MTX = methotrexate; LOCF = last observation carried forward; JSN = joint space narrowing; CI = confidence interval

Data from the open-label extension of Study DE019 indicate that the reduction in rate of progression of structural damage is maintained for 8 and 10 years in a subset of patients. At 8 years, 81 of 207 patients originally treated with 40 mg adalimumab every other week were evaluated radiographically. Among those, 59.3% (48 patients) showed no progression of structural damage defined by a change from baseline in the mTSS of 0.5 or less. At 10 years, 79 of 207 patients originally treated with 40 mg adalimumab every other week were evaluated radiographically. Among those, 50.6% (40 patients) showed no progression of structural damage defined by a change from baseline in the mTSS of 0.5 or less.

In Study DE013, adalimumab-treated patients had a mean duration of rheumatoid arthritis of

less than nine months and had not previously received methotrexate. Structural joint damage was assessed radiographically and expressed as change in modified total Sharp score (TSS). The Week 52 results are shown in **Table 26**. A statistically significant difference for change in modified total Sharp score, erosion score and JSN were observed at Week 52 and maintained at Week 104.

**Table 26. Radiographic Mean Change (95% Confidence Interval) in Study DE013**

Response		MTX <sup>a</sup> N = 257	Adalimumab <sup>a, b</sup> N = 274	Adalimumab + MTX N = 268
Week 52	Total Sharp Score	5.7 (4.2, 7.3)	3.0 (1.7, 4.3)	1.3 (0.5, 2.1)
	Erosion Score	3.7 (2.7, 4.8)	1.7 (1.0, 2.4)	0.8 (0.4, 1.2)
	JSN Score	2.0 (1.2, 2.8)	1.3 (0.5, 2.1)	0.5 (0.0, 1.0)
Week 104	Total Sharp Score	10.4 (7.7, 13.2)	5.5 (3.6, 7.4)	1.9 (0.9, 2.9)
	Erosion Score	6.4 (4.6, 8.2)	3.0 (2.0, 4.0)	1.0 (0.4, 1.6)
	JSN Score	4.1 (2.7, 5.4)	2.6 (1.5, 3.7)	0.9 (0.3, 1.5)

a.  $p < 0.001$  for adalimumab + MTX versus MTX at Week 52 and Week 104 and for adalimumab + MTX versus adalimumab at Week 104

b.  $p < 0.01$  for adalimumab + MTX versus adalimumab at Week 52

Definition(s): MTX = methotrexate; JSN = joint space narrowing

The percentage of patients without progression (change from baseline in modified total Sharp score  $\leq 0.5$ ) was significantly higher with adalimumab + methotrexate combination therapy compared to methotrexate monotherapy at Week 52 (63.8 and 37.4% respectively,  $p < 0.001$ ) and Week 104 (61.2 and 33.5% respectively,  $p < 0.001$ ).

### **Quality of Life and Physical Function Response**

In Studies DE009, DE011, DE019 and DE031, adalimumab showed significantly greater improvement than placebo in the disability index of Health Assessment Questionnaire (HAQ) from baseline to the end of study, and significantly greater improvement than placebo in the health outcomes as assessed by the Short Form Health Survey (SF-36). Improvement was seen in both the Physical Component Summary (PCS) and the Mental Component Summary (MCS).

In Study DE019, the mean (CI) improvement in HAQ from baseline at Week 52 was -0.60 (-0.65, -0.55) for the adalimumab patients and -0.25 (-0.33, -0.17) for placebo + methotrexate ( $p < 0.001$ ) patients. Eighty-two percent (82%) of adalimumab-treated patients who achieved a 0.5 or greater improvement in HAQ at Week 52 in the double-blind portion of the study maintained that improvement through Week 104 of open-label treatment, and a similar proportion of patients maintained this response through Week 260 (five years) and Week 520 (10 years). After five years, the proportion of subjects who were HAQ responders at the 0.22, 0.50, 0.75 and 1.0 levels were 76.5, 60.0, 47.5 and 30.8% respectively. A total of 149 patients who received adalimumab for 10 years were assessed for HAQ. After 10 years, the proportions of patients who were HAQ responders at the 0.22, 0.50, 0.75 and 1.0 levels were 73.8 (n = 110), 57.0 (n = 85), 44.3 (n = 66) and 26.2% (n = 39) respectively. Improvement in SF-36 was measured and maintained up to Week 156 (3 years).

In Study DE013, the active comparator-controlled study in early rheumatoid arthritis, the improvement in the HAQ disability index, and the physical component of the SF-36, showed greater improvement ( $p < 0.001$ ) for the adalimumab + methotrexate combination therapy versus the methotrexate monotherapy at Week 52, which was maintained through Week 104.

At Week 52 and Week 104 of treatment, 69.4% (186/268) and 63.8% (171/268) of subjects, respectively, treated with adalimumab + methotrexate combination therapy had a decrease (i.e., improvement) in the disability index of the HAQ of  $\geq 0.3$  units. In comparison, 61.5% (158/257;  $p = 0.562$ ) and 53.3% (137/257;  $p = 0.0146$ ) of subjects treated with methotrexate monotherapy, and 55.1% (151/274;  $p < 0.001$ ) and 48.2% (132/274;  $p < 0.001$ ) of subjects treated with adalimumab monotherapy had a decrease in the disability index of the HAQ of  $\geq 0.3$  units at Weeks 52 and 104, respectively.

### Psoriatic Arthritis

The efficacy of adalimumab was assessed in two randomized, double-blind, placebo-controlled studies in 413 patients. The primary study treated 313 adult patients with moderately to severely active psoriatic arthritis who had an inadequate response to nonsteroidal anti-inflammatory drug (NSAID) therapy. Of the 313 treated in this study, 158 (50.5%) were described as taking methotrexate at the time of randomization. Doses of adalimumab 40 mg every other week were administered for 24 weeks. **Table 27** summarizes the controlled clinical trials that were done in patients with active psoriatic arthritis.

**Table 27. Summary of Controlled Clinical Trials Supporting Safety and Efficacy in Patients with Psoriatic Arthritis**

Study #	Trial Design	Dosage, Route of Administration and Duration	Study Subjects (n)	Mean age (Range)	Gender (% Female)
M02-518 (PsA I)	Multicenter, double-blind, randomized, placebo-controlled, stratified by MTX use and extent of psoriasis ( $\geq 3\%$ or $< 3\%$ BSA)	Adalimumab 40 mg eow	151	49.6 $\pm$ 12.5	43.7
		Placebo Subcutaneous 24 weeks	162	49.2 $\pm$ 11.1	45.1
M02-570 (PsA II)	Multicenter, double-blind, randomized, placebo-controlled, stratified by DMARD use (yes, no)	Adalimumab 40 mg eow	51	50.4 $\pm$ 11.0	43.1
		Placebo Subcutaneous 24 weeks	49	47.7 $\pm$ 11.3	49.0
M02-518 and M02-570	Multicenter, double-blind, randomized, placebo-controlled,	Adalimumab 40 mg eow	202	49.1 $\pm$ 12.2	43.6
		Placebo Subcutaneous	211	48.9 $\pm$ 11.2	46.0

Study #	Trial Design	Dosage, Route of Administration and Duration	Study Subjects (n)	Mean age (Range)	Gender (% Female)
	stratified with MTX (M02-518), and DMARDs (M02-570)	24 weeks			

Definition(s): eow = every other week; MTX = methotrexate; BSA = body surface area; DMARDs = disease-modifying anti-rheumatic drugs

Mean ages across the two studies ranged from 47.7 years (placebo group, Study M02-570) to 50.4 years (adalimumab group, Study M02-570). Mean weight ranged from 85.5 kg (placebo group, Study M02-518) and 91.5 kg (adalimumab group, Study M02-570). The percentage of females ranged from 43.1 % (adalimumab group, Study M02-570) and 45.1% (placebo group, Study M02-518). Patients were predominantly Caucasian, with the percentage of Caucasian patients ranging from 93.8% (placebo group, Study M02-518) to 98.0% (adalimumab group, Study M02-570). There were no notable differences between the studies in any of the demographic characteristics analyzed. Upon completion of both studies, 383 patients enrolled in an open-label extension study (Table 28) in which adalimumab 40 mg is administered every other week.

**Table 28. Summary of Open-Label Clinical Trials Evaluating Long-Term Safety and Efficacy in Patients with Psoriatic Arthritis**

Study #	Trial Design	Dosage, Route of Administration and Duration	Study Subjects (n)	Mean age (Range)	Gender (% Female)
M02-537 (PsA III)	Multicenter, open-label, multi-national continuation of studies M02-518 and M02-570.	Adalimumab 40 mg eow Subcutaneous 120 weeks or when commercially available, whichever is later	395	49.0 ± 11.7 (20.0 to 88.0)	44.6

Definition(s): eow = every other week

### **Description of Clinical Studies**

Study M02-518 evaluated the effectiveness and safety of adalimumab either alone or in combination with concomitant methotrexate in subjects with moderately to severely active PsA who have had an inadequate response or intolerance to NSAID therapy.

Study M02-570 evaluated the effectiveness and safety of adalimumab either alone or in combination with any concomitant DMARD (except cyclosporine or tacrolimus) in subjects with moderately to severely active psoriatic arthritis who have had an inadequate response to DMARD therapy.

Study M02-537 evaluates the long-term safety and efficacy of adalimumab 40 mg every other week in the treatment of psoriatic arthritis in subjects who completed the controlled Studies M02-518 and M02-570.



## Study Results

### Clinical Response

*Studies M02-518, M02-570 and M02-537*

Adalimumab was superior to placebo in all measures of disease activity ( $p < 0.001$ ) as shown in **Table 29** and **Table 30**. Among patients with psoriatic arthritis who received adalimumab, the clinical responses were apparent at the time of the first visit (Week 2), significant at Week 12, and maintained at Week 24 in the double-blind period of the study. **Table 32** presents data from the ongoing open-label study regarding improvement in arthritic manifestations of psoriatic arthritis.

Patients with a psoriasis involvement of at least three percent body surface area (BSA) were evaluated for Psoriatic Area and Severity Index (PASI) responses. In these patients, the skin lesions of psoriasis were improved with adalimumab, relative to placebo, as measured by the PASI. Results were similar with and without concomitant methotrexate therapy. The small number of patients with moderate to severe psoriasis requires additional data to adequately assess the PASI response.

**Table 29. ACR and PASI Response in Placebo-Controlled Psoriatic Arthritis Study (Study M02-518) (Percent of Patients)**

Response		Placebo N = 162	Adalimumab <sup>†</sup> N = 151
ACR 20	Week 12	14%	58%
	Week 24	15%	57%
ACR 50	Week 12	4%	36%
	Week 24	6%	39%
ACR 70	Week 12	1%	20%
	Week 24	1%	23%
Response		Placebo N = 69	Adalimumab <sup>†</sup> N = 69
PASI 50	Week 12	15%	72%
	Week 24	12%	75%
PASI 75	Week 12	4%	49%
	Week 24	1%	59%

†  $p < 0.001$  for all comparisons between adalimumab and placebo

Definition(s): ACR = American College of Rheumatology; PASI = Psoriasis Area and Severity Index

**Table 30. Components of Disease Activity in Psoriatic Arthritis (Study M02-518)**

Parameter mean (median)	Placebo <sup>†</sup> N = 162		Adalimumab <sup>††</sup> N = 151	
	Baseline	Week 24	Baseline	Week 24
Number of tender joints (Scale 0 to 78)	25.8 (23.0)	22.3 (17.0)	23.3 (19.0)	11.8 (5.0)
Number of swollen joints (Scale 0 to 76)	14.6 (11.0)	12.1 (8.0)	13.4 (10.0)	7.6 (3.0)
Physician global assessment <sup>a</sup>	53.2 (53.0)	46.0 (48.0)	53.5 (54.0)	21.4 (16.0)
Patient global assessment <sup>a</sup>	47.2 (49.0)	47.6 (49.0)	47.5 (48.0)	24.2 (18.5)
Pain <sup>a</sup>	47.6 (47.5)	47.9 (49.0)	50.6 (53.0)	25.4 (19.0)
Disability index (HAQ) <sup>b</sup>	1.0 (1.0)	0.9 (0.8)	1.0 (0.9)	0.6 (0.4)
CRP (mg/dL) <sup>c</sup>	1.4 (0.8)	1.4 (0.7)	1.4 (0.8)	0.5 (0.2)

† As observed analysis presented, N at Week 24 may be less than 162 for placebo or 151 for

adalimumab

‡ p < 0.001 for adalimumab versus placebo comparisons based on mean change from baseline

- a. Visual analogue scale; 0 = best, 100 = worst
- b. Disability index of the Health Assessment Questionnaire (HAQ); 0 = best, 3 = worst; measures the patient's ability to perform the following: dress/groom, arise, eat, walk, reach, grip, maintain hygiene, and maintain daily activity
- c. C-reactive protein (CRP) normal range: 0 to 0.287 mg/dL

### **Radiographic Response**

Radiographic changes in the hands wrists, and feet were assessed in the psoriatic arthritis study at baseline and Week 24 during the double-blind period when patients were on adalimumab or placebo and at Week 48 when all patients were on open-label adalimumab. A modified total Sharp score (mTSS), which included distal interphalangeal joints (i.e., not identical to the TSS used for rheumatoid arthritis), was used by readers blinded to treatment group to assess the radiographs.

#### **Week 24**

The mean change in modified total Sharp score was evaluated and demonstrated that adalimumab-treated patients had significantly less progression in their X-rays, compared to placebo-treated patients. As shown in **Table 31** the mean change from baseline in both the erosion and the joint space narrowing scores in the adalimumab treatment group was significantly superior to placebo. As with other TNF agents, the median change in Sharp scores for both patient groups were zero.

**Table 31. Radiographic Mean Changes at Week 24 in Placebo-Controlled Psoriatic Arthritis Study (Study M02-518)<sup>†</sup>**

Response	Placebo N = 152	Adalimumab N = 144	p-value
Total Sharp score	1	-0.2	< 0.001
Erosion score	0.6	0	< 0.001
JSN score	0.4	-0.2	< 0.001

<sup>†</sup> Analysis of patients with X-ray films at both baseline and Week 24  
Definition(s): JSN = joint space narrowing

#### **Week 48**

Adalimumab-treated patients demonstrated greater inhibition of radiographic progression at Week 48 compared to placebo-treated patients at Week 24 (see **Table 32**).

**Table 32. Change in Modified Total Sharp Score<sup>‡</sup> in Psoriatic Arthritis (Study M02-537)**

Response		Placebo N = 141	Adalimumab N = 133	
		Week 24	Week 24	Week 48
Modified Total Sharp Score	Baseline mean	22.1	23.4	23.4
	Mean change ± SD	0.9 ± 3.06	-0.1 ± 1.69**	0.1 ± 2.74**
	Change (range)	-3.5 to 22.0	-6.8 to 12.5	-5.9 to 24.2
Erosion Score	Baseline mean	11.8	12.4	12.4

Response		Placebo	Adalimumab	
		N = 141	N = 133	
		Week 24	Week 24	Week 48
	Mean change ± SD	0.5 ± 1.91	0.0 ± 0.91**	0.1 ± 1.79*
	Change (range)	-2.2 to 14.5	-2.2 to 7.5	-4.4 to 16.5
JSN score	Baseline mean	10.4	11.0	11.0
	Mean change ± SD	0.4 ± 1.60	-0.1 ± 1.06**	0.0 ± 1.33**
	Change (range)	-3.5 to 10.2	-5.7 to 5.0	-4.0 to 7.7

\* p < 0.05 for the difference between adalimumab, Week 48 and placebo, Week 24 (primary analysis)

\*\* p < 0.001 for the difference between adalimumab, Week 48 and placebo, Week 24 (primary analysis)

‡ X-rays with less than 50% assessments were imputed

Definition(s): JSN = joint space narrowing; SD = standard deviation

### **Physical Function Response**

Disability and physical function were assessed in psoriatic arthritis study using Health Assessment Questionnaire Disability Index (HAQ-DI). The adalimumab-treated patients had significantly greater improvement in the disability index of the HAQ from baseline to Week 24, compared to placebo and were maintained up to Week 84 (see **Table 33** and **Table 34**).

**Table 33. Disability Index of the HAQ (Full Analysis Set) (Study M02-518)**

Response		Placebo		Adalimumab 40 mg eow		p-value <sup>a</sup>
		N = 162		N = 151		
		N	Mean ± SD	N	Mean ± SD	
Week 12	Baseline mean	154	1.0	142	1.0	< 0.001*
	Change (range)	154	-0.1 ± 0.45	142	-0.4 ± 0.45	
Week 24	Baseline mean	145	1.0	141	1.0	< 0.001*
	Change (range)	145	-0.1 ± 0.42	141	-0.4 ± 0.49	

\* Statistically significant at the p = 0.001 level

a. p-value for differences between treatment groups from an ANOVA model with treatment group and baseline methotrexate use/extent of psoriasis (≥ 3% BSA, < 3% BSA) as factors

Definition(s): HAQ = Health Assessment Questionnaire; BSA = body surface area; eow = every other week; SD = standard deviation

**Table 34. Mean Change From Baseline in Disability Index of HAQ by Visit (Observed) (Study M02-518 Subjects Randomized to Adalimumab)**

Visit	N	Baseline <sup>a</sup> Mean	Visit Mean	Change from Baseline		
				Mean	Standard Deviation	Range (Min to Max)
Week 24	137	1.0	0.6	-0.4	0.48	-1.8 to 1.1
Week 26	137	1.0	0.5	-0.4	0.50	-2.1 to 0.9
Week 30	137	1.0	0.6	-0.4	0.49	-1.9 to 1.0
Week 36	137	1.0	0.6	-0.4	0.50	-1.9 to 1.1
Week 42	135	1.0	0.6	-0.4	0.50	-1.9 to 1.0
Week 48	134	1.0	0.6	-0.4	0.54	-2.3 to 0.9

Visit	N	Baseline <sup>a</sup> Mean	Visit Mean	Change from Baseline		
				Mean	Standard Deviation	Range (Min to Max)
Week 60	132	1.0	0.5	-0.4	0.49	-1.9 to 0.6
Week 72	129	1.0	0.6	-0.4	0.49	-1.9 to 0.6
Week 84	79	0.9	0.5	-0.4	0.49	-1.9 to 0.8

Note: The disability index of the Health Assessment Questionnaire (HAQ) has a range from 0 to 3 with a higher score indicating a greater extent of functional limitations

a. Last assessment prior to the first adalimumab injection

A subset of the subjects is still being followed in the ongoing study.

Results from the Short Form Health Survey (SF-36) support these findings, with statistically significant Physical Component Summary (PCS) scores, as well as statistically significant pain and vitality domain scores at Week 24, which were maintained to Week 72.

### Ankylosing Spondylitis

#### **Study Demographics and Trial Design**

The safety and efficacy of adalimumab 40 mg every other week were assessed in 393 adult patients in two randomized, 24-week double-blind, placebo-controlled studies in patients with active ankylosing spondylitis who have had an inadequate response to or intolerance to one or more NSAIDs, and who may have additionally failed DMARD therapy. The larger study enrolled 315 adult patients with active ankylosing spondylitis [defined as fulfilling at least two of the following three criteria: (1) a Bath Ankylosing Spondylitis Disease Activity Index (BASDAI) score  $\geq 4$  cm, (2) a visual analogue score (VAS) for total back pain  $\geq 40$  mm, and (3) morning stiffness  $\geq 1$  hour]. The primary efficacy endpoint was percentage of ASAS 20 responders at Week 12 measured by the Assessment in Ankylosing Spondylitis (ASAS) response criteria.

Additional pre-determined endpoints included: response as defined by ASAS 5/6 criteria, ASAS 40/50/70 and partial remission, Bath Ankylosing Spondylitis Metrology Index (BASMI), Maastricht Ankylosing Spondylitis Enthesitis Score (MASES), and Bath Ankylosing Spondylitis Disease Activity Index (BASDAI). The blinded period was followed by an open-label period during which patients received adalimumab 40 mg every other week subcutaneously for up to an additional 80 weeks.

### **Study Results**

#### **Clinical Response**

Results showed statistically significant reduction in signs and symptoms of ankylosing spondylitis in patients treated with adalimumab compared to placebo in Study M03-607. Significant improvement in measures of disease activity was first observed at Week 2 and maintained through Week 24 as shown in **Figure 3** and **Table 35**.

Patients with total spinal ankylosis were included in the larger study (n = 11). Responses of these patients were similar to those without total ankylosis.

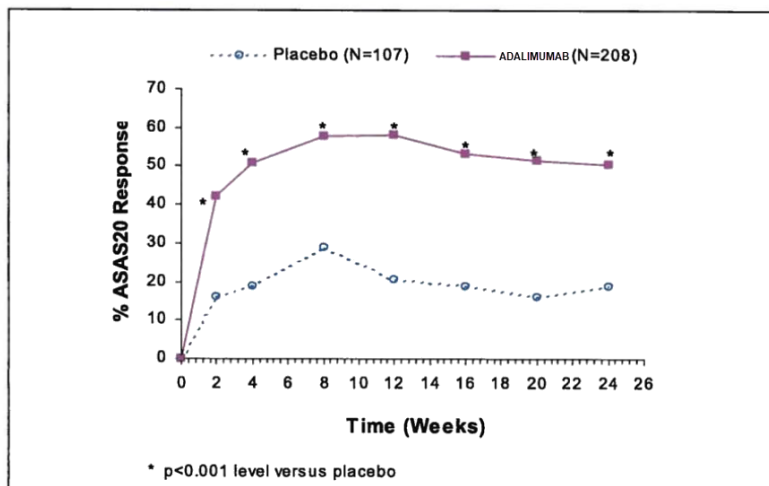

**Figure 3. ASAS 20 Response by Visit, Study M03-607**

At Week 12, the ASAS 20/50/70 responses were achieved by 58, 38, and 23%, respectively, of patients receiving adalimumab, compared to 21, 10, and 5% respectively, of patients receiving placebo ( $p < 0.001$ ). At Week 24, the ASAS 20/50/70 responses were achieved by 51, 35 and 24%, respectively, of patients receiving adalimumab, compared to 19, 11, and 8%, respectively, of patients receiving placebo ( $p < 0.001$ ). These results were sustained in patients receiving open-label adalimumab through Week 52.

In a sub-group analysis by region an adalimumab versus placebo treatment group difference was observed between the United States (US) and European (EU) subjects (21.7 and 50.9% respectively). This difference in the treatment effect is driven by the different placebo ASAS 20 response rates (33.3% for US versus 10.2% for EU). However, the adalimumab ASAS 20 response rates were 55 and 61.1% in the US and EU respectively.

A low level of disease activity [defined as a value  $< 20$  (on a scale of 0 to 100 mm) in each of the four ASAS response parameters] was achieved at Week 24 in 22% of adalimumab-treated patients versus 6% in placebo-treated patients ( $p < 0.001$ ).

Other secondary and additional measures of efficacy such as response as defined by ASAS 5/6 criteria, ASAS 40, metrology (BASMI), enthesitis (MASES), and disease activity (BASDAI) were statistically significant at Weeks 12 and 24.

**Table 35. Components of Ankylosing Spondylitis Disease Activity in Study M03-607**

Response	Placebo N = 107		Adalimumab N = 208	
	Baseline Mean	Week 24 Mean	Baseline Mean	Week 24 Mean
ASAS 20 Response Criteria*				
Patient's Global Assessment of Disease Activity <sup>a</sup>	65	60	63	38
Total Back Pain	67	58	65	37
Inflammation <sup>b</sup>	6.7	5.6	6.7	3.6
BASFI	56	51	52	34
BASDAI* Score	6.3	5.5	6.3	3.7
CRP*	2.2	2	1.8	0.6

a. Percent of subjects with at least a 20% and 10-unit improvement measured on a visual analogue scale (VAS) with 0 = "none" and 100 = "severe"

b. Mean of questions 5 and 6 of BASDAI

\* Statistically significant as  $p < 0.001$  for all comparisons between adalimumab and placebo at Week 24

Definition(s): BASFI = Bath Ankylosing Spondylitis Functional Index; BASDAI = Bath Ankylosing Spondylitis Disease Activity Index; CRP = C-reactive protein (mg/dL)

Similar results (not all statistically significant) were seen in the second randomized trial, a multicenter, double-blind, placebo-controlled study of 82 patients with ankylosing spondylitis (Study M03-606).

Patients treated with adalimumab achieved statistically significant greater improvement from baseline in the Ankylosing Spondylitis Quality of Life Questionnaire (ASQoL) score (-3.15 versus -0.95,  $p < 0.001$ ) and in the Short Form Health Survey (SF-36) Physical Component Summary (PCS) score (6.93 versus 1.55,  $p < 0.001$ ) compared to placebo-treated patients at Week 12, which were maintained through Week 24.

## Crohn's Disease

### **Study Demographics and Trial Design**

The safety and efficacy of multiple doses of adalimumab were assessed in over 1,500 adult patients with moderately to severely active Crohn's disease (Crohn's Disease Activity Index [CDAI]  $\geq 220$  and  $\leq 450$ ) in randomized, double-blind, placebo-controlled studies. Concomitant stable doses of aminosalicylates, corticosteroids, and/or immunomodulatory agents were permitted and 80% of patients continued to receive at least one of these medications.

**Table 36** summarizes the controlled clinical trials and **Table 37** summarizes the open-label clinical trials that were done in patients with moderately to severely active Crohn's disease.

**Table 36. Summary of Controlled Clinical Trials Supporting Safety and Efficacy in Patients with Crohn's Disease**

Study #	Trial Design	Dosage, Route of Administration and Duration	Study Subjects (n)	Mean age (Range)	Gender (% Female)
M02-403 (CD I)	Randomized, double-blind, placebo-controlled, multicenter, dose ranging study in anti-TNF naïve patients	Adalimumab 160 mg at Week 0 and 80 mg at Week 2; or Adalimumab 80 mg at Week 0 and 40 mg at Week 2; or Adalimumab 40 mg at Week 0 and 20 mg at Week 2;	225	39 ± 12 (18 to 79)	55.6
		Placebo Subcutaneous 4 weeks	74	37 ± 13 (19 to 74)	50.0
M04-691 (CD II)	Randomized, double-blind, placebo-controlled, multicenter study in patients who had lost response to or were intolerant to infliximab	Adalimumab 160 mg at Week 0 and 80 mg at Week 2	159	39.4 ± 11.9 (19 to 75)	68.6
		Placebo Subcutaneous 4 weeks	166	37.4 ± 11.9 (18 to 75)	60.8
M02-404 (CD III)	Randomized, double-blind, multicenter, placebo-controlled	<u>Initial Open-Label:</u> Adalimumab 80 mg at Week 0 and 40 mg at Week 2			
		<u>Post-Randomization (Week 4):</u> Adalimumab 40 mg eow	260	36.8 ± 11.5 (17 to 73)	62.7
		Adalimumab 40 mg ew	257	37.8 ± 12.1 (18 to 75)	61.1
		Placebo	261	36.9 ± 11.4 (18 to 75)	62.1
		Not randomized Subcutaneous 56 weeks	76	36.1 ± 13.6 (19 to 75)	60.5
M05-769 (CD VI)	Randomized, double-blind, placebo-controlled, multicenter, efficacy and safety study.	Patients received OL induction therapy of Adalimumab 160/80 mg at Weeks 0/2, and were stratified by responder status to Adalimumab 40 mg eow or placebo for up to 52 weeks. At Week 52, patients were switched to OL adalimumab 40 mg eow for up to an additional 36 weeks.)	64 65		

Study #	Trial Design	Dosage, Route of Administration and Duration	Study Subjects (n)	Mean age (Range)	Gender (% Female)
		adalimumab eow		37 (18 to 74)	62.5
		Placebo		37 (18 to 67)	63.1

Definition(s): ew = every week; eow = every other week; TNF = tumor necrosis factor; OL =open-label

**Table 37. Summary of Open-Label Clinical Trials Supporting Safety and Efficacy in Patients with Crohn's Disease**

Study #	Trial Design	Dosage, Route of Administration and Duration	Study Subjects (n)	Mean age (Range)	Gender (% Female)
M02-433 (CD IV)	Open-label extension of placebo-controlled Study M02-403	<p>Patients received OL adalimumab 40 mg at baseline (Week 0) and week 2. At Week 4, patients were assigned to one of three blinded treatment groups (adalimumab eow, ew, or placebo) or OL adalimumab eow treatment, based on clinical remission status at baseline.</p> <p>After 1 year (Week 56), patients entered long-term extension phase up to more than 5 years (including preceding M02-403 study); those receiving blinded treatment were switched to OL adalimumab eow, and those in the OL group continued their OL treatment.</p> <p>All</p>	276	39 (18 – 74)	54.7
M04-690 (CD V)	Open-label extension of placebo-controlled Studies M04-691 or M02-404	<p>Patients entering from a blinded cohort were assigned to OL adalimumab 40 mg eow; patients entering the study from an OL cohort continued their previous dosing regimen of eow or ew.</p> <p>Study M02-404 cohort</p> <p>Study M04-691 cohort</p>	467 310	All 38 (17 to 75)	All 62.4

Definition(s): ew = every week; eow = every other week; OL =open-label



## **Description of Clinical Studies**

Induction of clinical remission (defined as CDAI < 150) was evaluated in two studies, Studies M02-403 and M04-691.

In Study M02-403, 299 TNF-blocker naïve patients were randomized to one of four treatment groups; the placebo group received placebo at Weeks 0 and 2, the 160/80 group received 160 mg adalimumab at Week 0 and 80 mg at Week 2, the 80/40 group received 80 mg at Week 0 and 40 mg at Week 2, and the 40/20 group received 40 mg at Week 0 and 20 mg at Week 2.

In Study M04-691, 325 patients who had lost response or were intolerant to infliximab were randomized to receive either 160 mg adalimumab at Week 0 and 80 mg at Week 2 or placebo at Weeks 0 and 2.

Maintenance of clinical remission was evaluated in Study M02-404.

In Study M02-404, 854 patients received open-label 80 mg adalimumab at Week 0 and adalimumab 40 mg at Week 2. At Week 4, patients were stratified by their responder status and previous antitumor necrosis factor (TNF) use (no, yes) and randomized to one of three blinded treatment groups: adalimumab 40 mg every other week, adalimumab 40 mg every week or placebo with a total study duration of 56 weeks. Patients in clinical response (decrease in CDAI  $\geq$  70) at Week 4 were stratified and analyzed separately from those not in clinical response at Week 4.

Corticosteroid tapering was permitted after Week 8.

Study M05-769 assessed mucosal healing in 135 patients; patients received open-label induction therapy of adalimumab 160/80 mg at weeks 0/2, and were stratified by responder status to adalimumab 40 mg every other week (eow) or placebo for up to 52 weeks. At Week 52, patients were switched to open-label adalimumab 40 mg eow for up to an additional 36 weeks.

## **Study Results**

### **Clinical Responses**

#### **Studies M02-403 and M04-691**

A statistically significantly greater percentage of the patients treated with adalimumab 160/80 mg achieved induction of clinical remission versus placebo at Week 4 regardless of whether the patients were TNF-blocker naïve (Study M02-403) or had lost response or are intolerant to infliximab (Study M04-691) (**Table 38** and **Table 39**, respectively).

The percentage of subjects who achieved clinical remission with adalimumab 160/80 mg induction therapy was greater for those receiving corticosteroids versus those who did not.

**Table 38 Induction of Clinical Remission and Response in Infliximab Naïve Patients (Study M02-403) (Percent of Patients)**

Response		Placebo N = 74	Adalimumab 160/80 mg N = 76
Week 4	Clinical remission Difference <sup>a</sup> (95% CI)	12%	36%* 23.4 (10.3, 36.4)
	Clinical response (CR-100) Difference <sup>a</sup> (95% CI)	24%	49%** 24.4 (9.5, 39.3)
	Clinical response (CR-70) Difference <sup>a</sup> (95% CI)	34%	58%** 24.1 (8.6, 39.6)

All p-values are pairwise comparisons of proportions for adalimumab versus placebo  
\* p < 0.001  
\*\* p < 0.01  
a. Difference refers to the difference between the proportion (%) of adalimumab-treated subjects achieving clinical remission and clinical response compared with the placebo-treated subjects; 95% CI based on normal approximation of the binomial  
Definition(s): CI = confidence interval; Clinical remission = Crohn's Disease Activity Index (CDAI) score < 150;  
Clinical response 100 (CR-100) and a clinical response 70 (CR-70) = decreases from baseline in CDAI scores of at least 100 points and at least 70 points, respectively

**Table 39. Induction of Clinical Remission and Response in Infliximab Experienced Patients (Study M04-691) (Percent of Patients)**

Response		Placebo N = 166	Adalimumab 160/80 mg N = 159
Week 4	Clinical remission Difference <sup>a</sup> (95% CI)	7%	21%* 14.2 (6.7, 21.6)
	Clinical response (CR-100) Difference <sup>a</sup> (95% CI)	25%	38%** 13.7 (3.7, 23.7)
	Clinical response (CR-70) Difference <sup>a</sup> (95% CI)	34%	52%** 17.8 (7.3, 28.4)

p-values are pairwise comparisons of proportions for adalimumab versus placebo  
\* p < 0.001  
\*\* p < 0.01  
a. Difference refers to the difference between the proportion (%) of adalimumab-treated subjects achieving clinical remission and clinical response compared with the placebo-treated subjects; 95% CI based on normal approximation of the binomial  
Definition(s): CI = confidence interval; Clinical remission = Crohn's Disease Activity Index (CDAI) score < 150;  
Clinical response 100 (CR-100) and a clinical response 70 (CR-70) = decreases from baseline in CDAI scores of at least 100 points and at least 70 points, respectively

Clinical Remission at Week 4 by baseline predictors in infliximab experienced patients is presented in **Table 40**.

**Table 40. Clinical Remission at Week 4 by Baseline Predictors in Infliximab Experienced Patients (Study M04-691)**

Baseline Predictors		Placebo N = 166	Adalimumab 160/80 mg N = 159
Corticosteroid User		3/73 (4.1)	18/55 (32.7)
Corticosteroid Nonuser		9/93 (9.7)	16/104 (15.4)
Aminosalicylate User		6/60 (10.0)	6/45 (13.3)
Aminosalicylate Nonuser		6/106 (5.7)	28/114 (24.6)
CDAI Score	≤ 300	8/81 (9.9)	24/75 (32.0)
	> 300	4/85 (4.7)	10/84 (11.9)

Definition(s): CDAI = Crohn's disease activity index

Study M02-404

At Week 4, 58% (499/854) of patients were in clinical response and were assessed in the primary analysis. Of those in clinical response at Week 4, 48% had been previously exposed to other anti-TNF therapy. At Weeks 26 and 56, statistically significantly greater proportions of patients who were in clinical response at Week 4 achieved clinical remission in the adalimumab maintenance groups compared to patients in the placebo maintenance group (**Table 41**).

**Table 41. Maintenance of Clinical Remission and Response (Percent of Patients)**

Response		Placebo N = 166	Adalimumab 40 mg eow N = 172	Adalimumab 40 mg eow N = 157
Week 26	Clinical remission	17%	40%*	47%*
	Difference <sup>a</sup> (95% CI)		22.5 (13.2, 31.7)	29.4 (19.8, 39.1)
	Clinical response (CR-100)	27%	52%*	52%*
Week 56	Clinical response (CR-100)		25.3 (15.3, 35.3)	25.8 (15.5, 36.0)
	Clinical response (CR-70)	28%	54%*	56%*
	Difference <sup>a</sup> (95% CI)		25.8 (15.8, 35.9)	27.8 (17.5, 38.1)
Week 56	Clinical remission	12%	36%*	41%*
	Difference <sup>a</sup> (95% CI)		24.3 (15.6, 32.9)	29.6 (20.5, 38.7)
	Clinical response (CR-100)	17%	41%*	48%*
Week 56	Clinical response (CR-100)		24.8 (15.6, 34.0)	31.3 (21.7, 40.9)
	Clinical response (CR-70)	18%	43%*	49%*
Difference <sup>a</sup> (95% CI)			25.4 (16.9, 34.7)	31.4 (21.7, 41.1)

\* p < 0.001 for adalimumab versus placebo pairwise comparisons of proportions  
a. Difference refers to the difference between the proportion (%) of adalimumab-treated subjects achieving clinical remission and clinical response compared with the placebo-treated subjects; 95% CI based on normal approximation of the binomial  
Definition(s): eow = every other week; ew = every week; CI = confidence interval; Clinical remission = Crohn's Disease Activity Index (CDAI) score < 150; Clinical response 100 (CR-100) and clinical response 70 (CR-70) = decreases from baseline in CDAI scores of at least 100 points and at least 70 points, respectively

More patients receiving adalimumab maintenance therapy were able to achieve remission and discontinue corticosteroids for at least 90 days than those receiving placebo at Week 26 (19% adalimumab every other week and 15% adalimumab every week versus 3% placebo, p < 0.02) and at Week 56 (29% adalimumab every other week and 20% adalimumab every week versus 5% placebo, p < 0.01).

In Study M02-404, 117 patients had at least one draining fistula at Baseline and Screening. Of those, 23 out of 70 in the adalimumab group (both regimens) and 6 out of 47 in the placebo group had no draining fistula at the last two evaluations.

Of those in response at Week 4 who attained remission during the study, patients in the adalimumab maintenance groups maintained remission for a significantly longer time than patients in the placebo maintenance group (**Figure 4**)

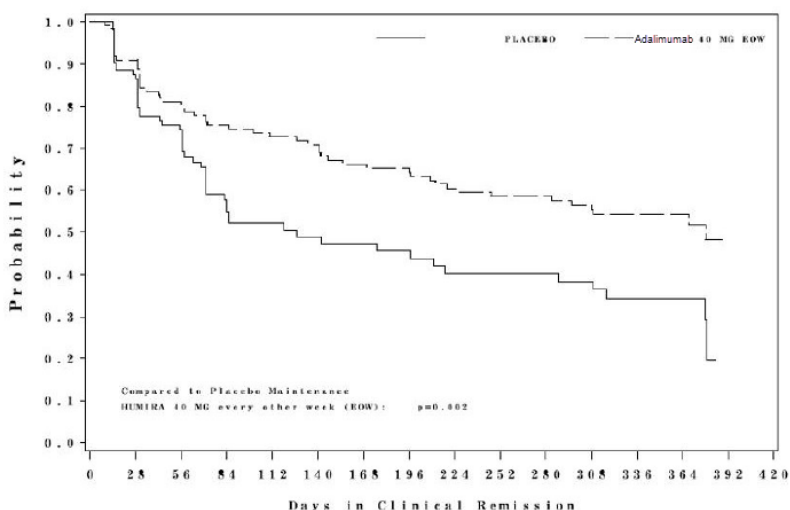

**Figure 4. Days in Clinical Remission for Patients Who Had Achieved Clinical Remission (Induction Period) by Week 4 in Study M02-404**

Some patients who experience decrease in their response may benefit from an increase in dose to adalimumab 40 mg every week. Supportive evidence for a restoration of clinical response as a result of dose escalation was derived from the modified-intent-to treat (mITT) Analysis Set of Study M02-404 in subjects who initially responded but lost response to adalimumab 40 mg every other week dosing. In those subjects who responded at Week 4, were in remission at Week 12 but lost remission after Week 12, and were dose escalated to adalimumab 40 mg every week ( $n = 14$ ), clinical remission was restored in 71% (10/14) of these subjects, with median time to restored clinical remission of 9 weeks.

Some patients who have not responded by Week 4 (induction period) may benefit from continued maintenance therapy through Week 12. Available data suggest that the clinical response is usually achieved at Week 4 of treatment. Continued therapy should be carefully reconsidered in a patient not responding within this time period.

Symptoms, overall well-being and functioning were assessed using the Inflammatory Bowel Disease Questionnaire (IBDQ). Treatment with adalimumab resulted in statistically significant improvements in IBDQ total score which measures bowel symptoms, systemic symptoms, emotional well-being and social functioning, compared with placebo ( $p < 0.001$ ) at Week 4 in Studies M02-403 and M04-691 and Weeks 26 and 56 in Study M02-404.

### Study M05-769

An endoscopy study (n=135) assessed rates of mucosal healing in patients with moderate to severe Crohn's Disease given either adalimumab or placebo. After 8 weeks of randomized treatment (Week 12 of study), although the results were not statistically significant ( $p = 0.056$ ), there was a trend towards higher levels of mucosal healing in subjects given adalimumab compared with subjects given placebo (mucosal healing in 27.4% (17/62) adalimumab vs 13.1% (8/61) given placebo. In this study, the placebo group received open-label adalimumab induction therapy.

### Ulcerative Colitis

#### **Study Demographics and Trial Design**

The safety and efficacy of multiple doses of adalimumab were assessed in adult patients with moderately to severely active ulcerative colitis (Mayo score 6 to 12 on a scale of 0 to 12 points, with an endoscopy subscore of 2 to 3 on a scale of 0 to 3) despite concurrent or prior treatment with immunosuppressants such as corticosteroids, azathioprine, or 6-MP in two randomized, double-blind, placebo-controlled studies (M06-826 and M06-827) and an open-label extension study. Both studies M06-826 and M06-827 enrolled TNF-blocker naïve patients, but M06-827 also allowed entry of patients who lost response or were intolerant to TNF-blockers. Forty percent (40%) of patients enrolled in Study M06-827 had previously used another TNF-blocker. Concomitant stable doses of aminosaliculates, corticosteroids, and/or immunomodulatory agents were permitted. In Studies M06-826 and M06-827, patients were receiving aminosaliculates (69%), corticosteroids (59%) and/or azathioprine or 6-MP (37%) at baseline. In both studies, 92% of patients continued to receive at least one of these medications.

**Table 42** summarizes the controlled clinical trials and **Table 43** summarizes the open-label clinical trial that were done in patients with ulcerative colitis (UC).

**Table 42. Summary of Controlled Clinical Trials Supporting Safety and Efficacy in Patients with Ulcerative Colitis**

Study #	Trial Design	Dosage, Route of Administration and Duration	Study Subjects (n)	Mean age (Range)	Gender (% Female)
M06-826 (UC I) (ULTRA I)	Randomized, double-blind (Weeks 0 to 8), placebo-controlled, multicenter induction study followed by an open-label extension (Weeks 8 to 52) in anti-TNF naïve subjects	adalimumab 160 mg at Week 0, 80 mg at Week 2, and 40 mg eow starting at Week 4	223*	38 ± 13 (18 to 75)	38.1
		adalimumab 80 mg at Week 0 and 40 mg eow starting at Week 2	130	42 ± 14 (18 to 75)	40.0
		Placebo	222*	40 ± 13 (18 to 74)	37.4
		Subcutaneous 52 weeks			

Study #	Trial Design	Dosage, Route of Administration and Duration	Study Subjects (n)	Mean age (Range)	Gender (% Female)
M06-827 (UC II) (ULTRA II)	Randomized, double-blind, placebo-controlled, multicenter induction and maintenance study	adalimumab 160 mg at Week 0, 80 mg at Week 2, and 40 mg eow starting at Week 4	248	40 ± 12 (18 to 72)	42.7
		Placebo	246	41 ± 13 (18 to 79)	38.2
		Subcutaneous 52 weeks			
Definition(s): ew = every week; eow = every other week * 130 subjects were randomized for the primary efficacy analysis					

**Table 43. Summary of Open-Label Clinical Trials Supporting Safety and Efficacy in Patients with Ulcerative Colitis**

Study #	Trial Design	Dosage, Route of Administration and Duration	Study Subjects (n)	Mean age (Range)	Gender (% Female)
M10-223 (UC III)	Open-label extension of controlled Studies M06-826 and M06-827	Patients entering the study from a blinded cohort were assigned to adalimumab 40 mg eow; those entering the study from an open-label cohort continued their previous dosing regimen of adalimumab 40 mg eow or ew.  Subcutaneous  up to 292 weeks	498	42 ± 13 (19 to 76)	36.9
Definition(s): ew = every week; eow = every other week					

### Description of Clinical Studies

Induction of clinical remission (defined as Mayo score ≤ 2 with no individual subscore > 1) at Week 8 was evaluated in Study M06-826. In Study M06-826, 390 TNF- blocker naïve patients were randomized to one of three treatment groups for the primary efficacy analysis. The placebo group received placebo at Week 0, 2, 4 and 6. The 160/80 group received 160 mg adalimumab at Week 0 and 80 mg at Week 2, and the 80/40 group received 80 mg adalimumab at Week 0 and 40 mg at Week 2. After Week 2, patients in both adalimumab treatment groups received 40 mg every other week (eow). Clinical remission was assessed at Week 8.

Induction of clinical remission at Week 8, clinical remission at Week 52 and sustained clinical remission (defined as clinical remission at both Weeks 8 and 52) were studied in Study M06-827. In Study M06-827, 518 patients were randomized to receive either adalimumab 160 mg at Week 0, 80 mg at Week 2, and 40 mg eow starting at Week 4 through Week 50, or placebo starting at Week 0 and eow through Week 50. Corticosteroid taper was permitted starting at Week 8.

### Study Results

## **Clinical Responses**

In both Studies M06-826 and M06-827, a greater proportion of subjects induced with 160/80 mg adalimumab achieved clinical remission versus placebo at Week 8 (**Table 44**). In Study M06-826, there was no statistically significant difference in clinical remission observed between the adalimumab 80/40 mg group and the placebo group at Week 8 and no statistically significant difference in clinical response or mucosal healing observed between the adalimumab 160/80 mg group and the placebo group at Week 8. Response at Week 8 was achieved by 54.6% (71/130) in the adalimumab 160/80 mg group and 44.6% (58/130) in the placebo group with a treatment difference and 95% confidence interval (CI) of 10.0% (-2.1, 22.1). Mucosal healing at Week 8 was achieved by 46.9% (61/130) in the adalimumab group and 41.5% (54/130) in the placebo group with a treatment difference and 95% CI of 5.4% (-6.7, 17.4).

In Study M06-827 clinical remission at Week 52 was a co-primary endpoint, achieved by 17.3% (43/248) of the adalimumab group and 8.5% (21/246) of the placebo group. Sustained clinical remission (at both Weeks 8 and 52) was achieved by 8.5% (21/248) of the adalimumab group and 4.1% (10/246) of the placebo group. Among those treated with adalimumab who were in remission at Week 8, 51% (21/41) were in remission at Week 52. In the adalimumab group 46.8% (116/248) patients moved to open label escape therapy for lack of response and 54.9% (135/246) patients in the placebo group. During the double-blind period, 5.6% (14/248) in the adalimumab group and 7.7% (19/246) in the placebo group withdrew without final evaluation due to non-colitis related reasons (not lack of efficacy or colitis related adverse event). In the adalimumab group 79 (31.9%) patients completed the Week 8 and 52 visits and 56 (22.8%) patients in the placebo group.

Response at Week 8 and at Week 52 were achieved in 50.4% (125/248) and 30.2% (75/248) of the adalimumab group and 34.6% (85/246) and 18.3% (45/246) in the placebo group respectively with a treatment difference and 95% CI of 15.9% (7.0, 24.2) and 11.9% (4.3, 19.2). Sustained response (at both Weeks 8 and 52) was achieved by 23.8% (59/248) of the adalimumab group and 12.2% (30/246) of the placebo group with a treatment difference and 95% CI of 11.6% (4.7, 18.1).

Mucosal healing (endoscopic improvement of the mucosa) at Week 8 and at Week 52 were achieved in 41.1% (102/248) and 25.0% (62/248) in the adalimumab group and 31.7% (78/246) and 15.4% (38/246) of the placebo group with a treatment difference and 95% CI of 9.4% (0.8, 17.6) and 9.6% (2.3, 16.4). Sustained mucosal healing (at both Weeks 8 and 52) was achieved by 18.5% (46/248) of the adalimumab group and 10.6% (26/246) of the placebo group with a treatment difference and 95% CI of 8.0% (1.6, 14.0).

In the adalimumab group, 13.3% (20/150) of the patients who were on corticosteroids at baseline were able to discontinue corticosteroids before Week 52 and achieved remission at Week 52 compared to 5.7% (8/140) in the placebo group.

**Table 44. Study M06-826 and M06-827: Summary of Results of Primary and Ranked Co-Primary and Ranked Secondary Endpoints**

Analysis <sup>a</sup>	Placebo	Adalimumab 160/80/40	Treatment Difference (95% CI)
<b>Study M06-826</b>	<b>N = 130</b>	<b>N = 130</b>	
<b>Primary Endpoint</b>			
Clinical remission at Week 8	9.2%	18.5%*	9.2 (0.9, 17.6)
<b>Study M06-827</b>	<b>N = 246</b>	<b>N = 248</b>	
<b>Ranked Co-Primary Endpoints</b>			
1. Remission at Week 8	9.3%	16.5%*	7.2 (1.2, 12.9)
2. Remission at Week 52	8.5%	17.3%*	8.8 (2.8, 14.5)
<p>Note: According to the NRI method, all missing remission values were considered to be non-remission. Subjects who switched to OL adalimumab were considered to be non-remitters at and after the time of the switch.</p> <p>Clinical remission per Mayo score: Mayo score <math>\geq 2</math> with no individual subscore <math>&gt; 1</math></p> <p>Mayo score consists of four subscores (stool frequency [SFS], rectal bleeding [RBS], findings of endoscopy, and physician's global assessment). Mayo scores range from 0-12.</p> <p>*<math>p &lt; 0.05</math> for adalimumab vs. placebo pairwise comparison of proportions</p>			

In the subgroup of patients in Study M06-827 with prior TNF-blocker use, the treatment difference for induction of clinical remission was lower than that seen in the whole study population, and the treatment differences for sustained clinical remission and clinical remission at Week 52 appeared to be similar to those seen in the whole study population.

### Hidradenitis Suppurativa

#### **Study Demographics and Trial Design**

The safety and efficacy of adalimumab were assessed in two randomized, double-blind, placebo-controlled studies in adult patients with moderate to severe hidradenitis suppurativa (HS) who were intolerant, had a contraindication or an inadequate response to systemic antibiotic therapy. In both studies, patients had Hurley Stage II or III disease with at least 3 abscesses or inflammatory nodules. **Table 45** summarizes the clinical trials in patients with moderate to severe hidradenitis suppurativa.



**Table 45. Summary of Clinical Trials Evaluating Safety and Efficacy in Patients with Hidradenitis Suppurativa**

Study #	Trial Design	Dosage, Route of Administration and Duration	Study Subjects (n)	Mean age (Range)	Gender (% Female)
M11-313 (Pioneer I)	Randomized, double-blind, placebo-controlled, 2-period	<p><u>Period A - 12 weeks</u> Adalimumab 160 mg at Week 0, 80 mg at Week 2, then 40 mg every week from Week 4 to Week 11; Placebo</p> <p><u>Period B - 24 weeks</u> Adalimumab 40 mg every week; Adalimumab 40 mg every other week; Placebo</p> <p>Subcutaneous 36 weeks</p>	307	37 (18 to 67)	63.8
M11-810 (Pioneer II)	Randomized, double-blind, placebo-controlled, 2-period	<p><u>Period A - 12 weeks</u> Adalimumab 160 mg at Week 0, 80 mg at Week 2, then 40 mg every week from Week 4 to Week 11; Placebo</p> <p><u>Period B - 24 weeks</u> Adalimumab 40 mg every week; Adalimumab 40 mg every other week; Placebo</p> <p>Subcutaneous 36 weeks</p>	326	35.5 (18 to 69)	67.8

Definition(s): ew = every week; eow = every other week

### Description of Clinical Studies

Both studies consisted of an initial 12-week double-blind treatment period (Period A), and a subsequent 24-week double-blind treatment period (Period B). In Period A, patients received placebo or adalimumab at an initial dose of 160 mg at Week 0, 80 mg at Week 2, and 40 mg every week starting at Week 4 to Week 11. After 12 weeks of therapy, patients who had received adalimumab in Period A were re-randomized in Period B to 1 of 3 treatment groups (adalimumab 40 mg every week, adalimumab 40 mg every other week, or placebo from Week 12 to Week 35). In Period B, patients who had been randomized to placebo in Period A were assigned to receive adalimumab 40 mg every week (M11-313) or placebo (M11-810) in a blinded fashion. In both studies, the randomization in Period A was to be stratified by baseline Hurley Stage (II versus III). A subject's Hurley Stage was determined by the worst Hurley Stage across all affected anatomic regions. Baseline concomitant antibiotic use (yes versus no) was an additional randomisation factor in Study M11-810.

Both studies evaluated Hidradenitis Suppurativa Clinical Response (HiSCR) at Week 12 as the primary endpoint. Reduction of inflammatory lesions and prevention of worsening of abscesses and draining fistulas was assessed using HiSCR which was defined as achieving at least a 50% reduction from baseline in AN [total abscess and inflammatory nodule] count plus no increase in abscess count and no increase in draining fistula count relative to baseline. Reduction in HS-related skin pain was assessed using a Numeric Rating Scale in patients who entered the study with an initial baseline score of 3 or greater on a 11 point scale.

The majority of patients were female, obese ( $\geq 90$  kg, BMI  $\geq 30$ ), current smokers, and had HS disease duration of over 9 years; the patients had a mean modified Sartorius Score of 131.6, AN count of 12.8, and draining fistula count of 3.8.

Patients participating in Studies M11-313 and M11-810 were eligible to enroll into an open-label extension study (Study M12-555) in which adalimumab 40 mg was administered every week. Study M12-555 aimed to determine the long-term safety, tolerability and efficacy of adalimumab in subjects with moderate to severe HS for at least 60 weeks. Throughout all 3 studies, patients used topical antiseptic wash daily.

## **Study Results**

### **Clinical Responses**

#### **Studies M11-313 and M11-810**

In Period A of Studies M11-313 and M11-810, 40 mg of adalimumab treatment every week resulted in statistically significant greater proportion of patients achieving HiSCR at Week 12 in subjects with moderate to severe HS compared with placebo. Results are shown in **Table 46**.

**Table 46. Clinical Response at 12 Weeks, M11-313 and M11-810**

Endpoint	M11-313 (PIONEER I)		M11-810 (PIONEER II)	
	Placebo	Adalimumab 40 mg weekly	Placebo	Adalimumab 40 mg weekly
Hidradenitis Suppurativa Clinical Response (HiSCR)	N = 154 40 (26.0%)	N = 153 64 (41.8%)	N = 163 45 (27.6%)	N = 163 96 (58.9%)
Difference (95% CI) <sup>a</sup>	15.9 % (5.3%, 26.5%)		31.5% (20.7, 42.2%)	
P-value <sup>b</sup>	0.003		< 0.001	

- 95% CI for stratum-adjusted difference was calculated according to the extended Mantel-Haenszel statistic for the comparison of two treatment groups, adjusting for baseline Hurley Stage (II/III) in M11-313 and adjusting for baseline Hurley Stage (II/III) and baseline antibiotic use (Yes/No) in M11-810.
- P-value was calculated from the Cochran-Mantel-Haenszel test adjusting for baseline Hurley Stage (II/III) in M11-313, and adjusting for baseline Hurley Stage (II/III) and baseline antibiotic use (Yes/No) in M11-810.

At Week 12, a significantly higher proportion of patients treated with adalimumab in Study M11-810 experienced at least a 30% decrease in HS-related skin pain versus placebo (45.7% vs 20.7%,  $P < 0.001$ ), whereas the difference was not significant in Study M11-313 (27.9% vs 24.8%,  $P = 0.628$ ). During the initial 12 weeks of treatment, 13.7% of patients treated with adalimumab experienced flare compared to 35.7% in the placebo group in Study M11-313. The

corresponding observed percentage was 11.0% and 35.0% for the adalimumab and placebo group, respectively, in Study M11-810.

Among patients who were randomized to adalimumab in Period A, achieved HiSCR at Week 12, and re-randomized to adalimumab every week (N = 52), adalimumab every other week (N = 52) and placebo (N = 53), 24 (46.2%), 22 (42.3%), and 32 (60.4%) discontinued prior to Week 36, respectively; 17 (32.7%), 20 (38.5%), and 27 (50.9%) discontinued primarily due to experiencing protocol specified loss of response.

In patients with at least a partial response ( $\geq 25\%$  improvement in AN count) to adalimumab 40 mg weekly at Week 12, the proportion of patients achieving HiSCR at Week 24 was 57.1% in adalimumab 40 mg weekly, 51.4% in adalimumab 40 mg every other week and 32.9% in the placebo group. The corresponding proportion at Week 36 was 55.7% in adalimumab 40 mg weekly, 40.0% in adalimumab 40 mg every other week and 30.1% in the placebo group.

## Plaque Psoriasis

### Study Demographics and Trial Design

The safety and efficacy of adalimumab were assessed in over 1,600 patients 18 years of age or older with moderate to severe chronic plaque psoriasis who were candidates for systemic therapy or phototherapy in randomized, double-blind, well-controlled studies.

**Table 47** summarizes the controlled clinical trials that were done in patients with moderate to severe plaque psoriasis.

**Table 47. Summary of Controlled Clinical Trials Supporting Safety and Efficacy in Patients with Psoriasis**

Study #	Trial Design	Dosage, Route of Administration and Duration	Study Subjects (n)	Mean age (Range)	Gender (% Female)
M03-656 (Ps I)	<p><u>Period A:</u> Double-blind, placebo-controlled treatment period in patients with moderate to severe chronic plaque psoriasis (PASI <math>\geq 12</math>, BSA <math>\geq 10\%</math>); patients were randomly assigned (2:1) to receive adalimumab or placebo</p> <p><u>Period B:</u> Open-label treatment period; all patients who achieved a <math>\geq</math> PASI 75 response at Week 16 received adalimumab</p>	<p><u>Initial Dose</u> Adalimumab 80 mg</p>	814	44.1 $\pm$ 13.2	32.9
		<p><u>Period A - 16 weeks</u> Adalimumab 40 mg eow Placebo</p>	398	45.4 $\pm$ 13.4	35.4
		<p><u>Period B - 17 weeks</u> Adalimumab 40 mg eow</p>	606	43.9 $\pm$ 13.2	30.7
		<p><u>Period C - 19 weeks</u> Adalimumab 40 mg eow Placebo</p> <p>Subcutaneous 52 weeks</p>	250	44.3 $\pm$ 13.0	

Study #	Trial Design	Dosage, Route of Administration and Duration	Study Subjects (n)	Mean age (Range)	Gender (% Female)
	<u>Period C</u> : Double-blind, placebo-controlled treatment period; patients who maintained a $\geq$ PASI 75 response at Week 33 and were originally randomized to active therapy in Period A were rerandomized (1:1) to receive adalimumab or placebo		240	43.4 $\pm$ 13.2	29.6 25.4
M04-716 (Ps II)	Randomized, double-blind, double-dummy, multicenter, placebo- and active-controlled study in patients with moderate to severe plaque psoriasis (PASI $\geq$ 10, BSA $\geq$ 10%) who were candidates for systemic therapy or phototherapy and had inadequate response to topical therapy	Adalimumab 80 mg followed by 40 mg eow  Placebo  MTX capsules (7.5 to 25.0 mg) Subcutaneous and oral 16 weeks	108  53  110	42.9 $\pm$ 12.6  40.7 $\pm$ 11.4  41.6 $\pm$ 12.0	35.2  34.0  33.6
M02-528 (Ps III)	Randomized, double-blind, placebo-controlled, multicenter, dose-ranging study in patients with moderate to severe plaque psoriasis (BSA $\geq$ 5%) and inadequate response to topical therapy	Adalimumab 80 mg followed by 40 mg eow Adalimumab 80 mg followed by 40 mg ew Placebo Subcutaneous 12 weeks	45 50 52	45.8 $\pm$ 11.6  43.8 $\pm$ 13.3  43.3 $\pm$ 13.1	28.9  34.0  34.6

Study #	Trial Design	Dosage, Route of Administration and Duration	Study Subjects (n)	Mean age (Range)	Gender (% Female)
M13-674 (Ps IV)	<p><u>Period A:</u> Double-blind, placebo-controlled treatment period during which patients with moderate to severe nail psoriasis (PGA and PGA-F of at least moderate disease severity; a target-fingernail mNAPSI <math>\geq 8</math> together with either BSA <math>\geq 10\%</math> or a total mNAPSI score of <math>\geq 20</math> with <math>\geq 5\%</math> BSA involvement) were randomized in a 1:1 ratio to receive adalimumab or placebo</p> <p><u>Period B:</u> Open-label treatment period; all patients received adalimumab</p>	<p>Period A - 26 weeks Adalimumab 80 mg followed by 40 mg eow Placebo</p> <p>Period B - 26 weeks Adalimumab 40 mg eow Subcutaneous 52 weeks</p>	217	46.7 $\pm$ 12.0	15.7
<p>Definition(s): ew = every week; eow = every other week; MTX = methotrexate; PASI = Psoriasis Area and Severity Index; BSA = body surface area; PGA = Physician's Global Assessment; PGA-F: Physician's Global Assessment of Fingernail Psoriasis; mNAPSI = Modified Nail Psoriasis Severity Index</p>					

Study M03-656 completed 160 weeks from the first dose of adalimumab in M03-656 to the end of the first portion of the extension trial.

## **Study Results**

### **Clinical Response**

In Studies M03-656, M04-716 and M02-528, the primary endpoint was the proportion of patients who achieved a reduction in PASI score of at least 75% (PASI 75) from baseline at Week 16 for Studies M03-656 and M04-716 and Week 12 for Study M02-528. Other evaluated outcomes in Studies M03-656, M04-716 and M02-528 included the PGA and other PASI measures.

Study M03-656 had an additional primary endpoint of loss of adequate response after Week 33 and on or before Week 52. Loss of adequate response is defined as a PASI score after Week 33 and on or before Week 52 that resulted in a  $<$  PASI 50 response relative to baseline with a minimum of a 6-point increase in PASI score relative to Week 33.

In Study M03-656, response to adalimumab was rapid, with significantly greater improvements compared to placebo in mean percentage PASI, PASI 75/90 response rates, and PGA clear or minimal scores by Week 4, the first study visit (all  $p < 0.001$  vs. placebo).

In Studies M03-656 and M04-716, more patients randomized to adalimumab than to placebo achieved at least a 75% reduction from baseline of PASI score at Week 16 (see **Table 48** and **Table 49**). Other relevant clinical parameters, including PASI 90, PASI 100 (corresponding to a complete clearance of psoriasis skin signs) and PGA of “clear or minimal,” were also improved over placebo.

In Study M04-716, superior results were achieved for PASI 75, PASI 90, PASI 100 and PGA of “clear or minimal” in patients randomized to the adalimumab treatment group versus those randomized to receive methotrexate.

**Table 48. Psoriasis Study M03-656 Efficacy Results at Week 16 (Percent of Patients)**

Response	Placebo N = 398	Adalimumab 40 mg eow N = 814
≥ PASI 75	6.5%	70.9% <sup>a</sup>
≥ PASI 90	1.8%	45.0% <sup>a</sup>
PASI 100	0.8%	20.0% <sup>a</sup>
PGA: Clear/minimal	4.3%	62.2% <sup>a</sup>

a.  $p < 0.001$  for adalimumab versus placebo  
 Definition(s): eow = every other week; PASI = Psoriasis Area Severity index; PGA = physician’s global assessment

**Table 49. Psoriasis Study M04-716 Efficacy Results at Week 16 (Percent of Patients)**

Response	Placebo N = 53	MTX N = 110	Adalimumab 40 mg eow N = 108
≥ PASI 75	18.9%	35.5%	79.6% <sup>a,b</sup>
≥ PASI 90	11.3%	13.6%	51.9% <sup>a,b</sup>
PASI 100	1.9%	7.3%	16.7% <sup>c,d</sup>
PGA: Clear/minimal	11.3%	30.0%	73.1% <sup>a,b</sup>

a.  $p < 0.001$  for adalimumab versus placebo  
 b.  $p < 0.001$  for adalimumab versus methotrexate  
 c.  $p < 0.01$  for adalimumab versus placebo  
 d.  $p < 0.05$  for adalimumab versus methotrexate  
 Definition(s): MTX = methotrexate; eow = every other week; PASI = Psoriasis Area Severity index; PGA = physician’s global assessment

PASI 75, PASI 90 and PASI 100 Responses from Week 0 to Week 24 for Study M03-656 are presented in **Figure 5**.

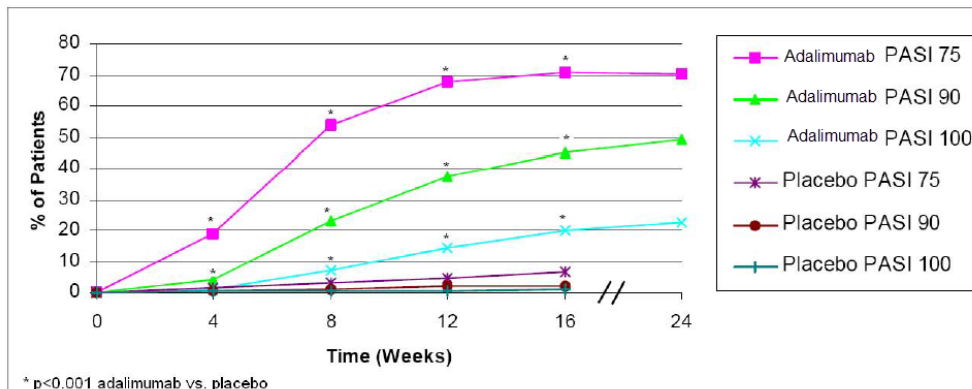

**Figure 5. Psoriasis Study M03-656 Response Rate from Week 0 to Week 24**

Results from Study M02-528 supported the efficacy demonstrated in Studies M03-656 and M04-716.

In Study M03-656, patients who were PASI 75 responders and were re-randomized to continue adalimumab therapy at Week 33 were less likely to experience a loss of adequate response on or before Week 52 than the PASI 75 responders who were re-randomized to placebo at Week 33 (4.9% versus 28.4%,  $p < 0.001$ ).

A total of 233 PASI 75 responders at Week 16 and Week 33 received continuous adalimumab therapy for 52 weeks in Psoriasis Study M03-656, and continued adalimumab in the open-label extension trial. The proportion of patients with full skin clearance (PASI 100) was generally maintained through Week 108 [31.8% at OLE entry ( $n=74/233$ ); 30.1% at Week 108 ( $n=69/229$  (total of 160 weeks)].

A total of 94 patients were randomized to adalimumab therapy in Psoriasis Study M04-716, and continued adalimumab in the open label extension trial. The proportion of patients with PASI 75 after an additional 108 weeks of open-label therapy was 58.1% ( $n=54/93$ ) (total of 124 weeks).

A total of 347 stable responders participated in a withdrawal and retreatment evaluation in an open-label extension study. Median time to relapse (decline to PGA “moderate” or worse) was approximately 5 months [95% C.I. (127, 146 days)]. None of these patients experienced rebound during the withdrawal period. A total of 76.5% (218/285) of patients who entered the retreatment period had a response of PGA “clear” or “minimal” after 16 weeks of retreatment, 69.1% (123/178) for patients who relapsed and 88.8% (95/107) for patients who did not relapse during the withdrawal period.

In the open-label extension study, 349/1,256 (27.8%) patients dose escalated from 40 mg every other week to 40 mg weekly due to a PASI response below 50% and were evaluated 12 weeks after dose escalation, and 93/349 (26.6%) patients achieved PASI 75 response.

There were no clinical trials conducted to evaluate the efficacy and safety of adalimumab in psoriatic arthritis patients with both active arthritis and moderate to severe psoriasis.

Study M13-674 evaluated the proportion of patients who achieved “clear” or “minimal” nail psoriasis with at least a 2-grade improvement on the 5-point Physician’s Global Assessment of

Fingernail Psoriasis (PGA-F) scale and at least a 75% improvement in Modified Nail Psoriasis Severity Index (mNAPSI 75) at Week 26. At Week 26, a statistically significantly higher proportion of patients in the adalimumab group achieved a PGA-F and mNAPSI 75 response compared with placebo (see **Table 50**).

**Table 50. Nail Psoriasis Study M13-674 Efficacy Results at 26 Weeks**

Response	Placebo N = 108	Adalimumab 40 mg eow N = 109
PGA-F clear/minimal and ≥ 2-grade improvement	6.9%	48.9% <sup>a,b</sup>
≥ mNAPSI 75	3.4%	46.6% <sup>a,b</sup>
<p>a. <math>p &lt; 0.001</math> for Adalimumab versus placebo</p> <p>b. Across all the strata, <math>P</math> value was calculated according to the Cochran-Mantel-Haenszel test adjusted for strata. If zero frequency occurred, strata were dropped and <math>P</math> value was calculated based on Chi-square test (or adjusted Chi-square test based on Campbell (2007) if expected count <math>&lt; 5</math> in any cell).</p>		

### **Quality of Life**

Patient Reported Outcomes (PRO) were evaluated by several measures. Quality of Life was assessed using the disease-specific Dermatology Life Quality Index (DLQI) in Study M03-656 and Study M04-716.

In Study M03-656, patients receiving adalimumab demonstrated clinically meaningful improvement in the DLQI total score, disease severity, pain, and pruritus compared to the placebo group at both Weeks 4 and 16. The DLQI result was maintained at Week 52.

In Study M04-716, patients receiving adalimumab demonstrated clinically meaningful improvement in the DLQI total score, disease severity, and pruritus compared to the placebo and methotrexate groups at Week 16, and clinically meaningful improvement in pain compared to the placebo group at Week 16.

The Short Form Health Survey (SF-36) was used to assess general health-related quality of life in Study M03-656. The adalimumab-treated patients had significantly greater improvement in the SF-36 Physical Component Summary (PCS) and Mental Component Summary (MCS) scores.

### **Uveitis**

### **Study Demographics and Trial Design**

The safety and efficacy of adalimumab were assessed in adult patients with non-infectious intermediate, posterior, and panuveitis (also known as “non-infectious uveitis affecting the posterior segment”), excluding patients with isolated anterior uveitis, in two randomized, doublemasked, placebo-controlled studies (M10-877 and M10-880) and an ongoing open-label extension study (M11-327). Patients received placebo or adalimumab at an initial dose of 80 mg followed by 40 mg every other week starting one week after the initial dose. Concomitant stable doses of non-biologic immunosuppressants were permitted.

**Table 51** summarizes the controlled and open-label extension clinical trials in patients with



uveitis.

**Table 51. Summary of Clinical Trials Supporting Safety and Efficacy in Patients with Uveitis**

Study #	Trial Design	Dosage, Route of Administration and Duration	Study Subjects (n)	Mean age (Range)	Gender (% Female)
M10-877 (VISUAL I)	Randomized, double-masked, placebo-controlled, multicenter study	Adalimumab 80 mg loading dose, followed by 40 mg given eow starting at Week 1 Placebo Subcutaneous Up to 80 weeks	110	42.7± 15.6 (18 to 81)	53.6
			107	42.6± 14.2 (18 to 79)	60.7
M10-880 (VISUAL II)	Randomized, double-masked, placebo-controlled, multicenter study	Adalimumab 80 mg loading dose, followed by 40 mg given eow SC starting at Week 1 Placebo Subcutaneous Up to 80 weeks	115	42.9 ±12.9 (18 to 75)	57.4
			111	42.2±13.98 (20 to 29)	64.9
M11-327 (VISUAL III)	Open-label extension of controlled Studies M10-877 and M10-880 for patients who had either discontinued from the lead-in studies for having met “treatment failure” criteria (active uveitis subgroup) or had completed the lead-in studies without treatment failure (inactive uveitis subgroup)	Adalimumab 40 mg eow  Subcutaneous  Up to 362 weeks	424	43.4 ±14.1 (19.0 to 81.0)	58.7

Definition(s): eow = every other week; SC = subcutaneous

### Description of Clinical Studies

The primary efficacy endpoint in both controlled studies was “time to treatment failure”. Treatment failure was defined by a multi-component measurement assessing the loss of disease control based on inflammatory chorioretinal and/or inflammatory retinal vascular lesions, anterior chamber (AC) cell grade, vitreous haze (VH) grade and best corrected visual acuity (BCVA).

Study M10-877 evaluated 217 patients with active uveitis despite treatment with corticosteroids

(oral prednisone at a dose of 10 to 60 mg/day). All patients received a standardized dose of prednisone 60 mg/day at study entry followed by a mandatory taper schedule, with complete corticosteroid discontinuation by Week 15.

Study M10-880 evaluated 226 patients with inactive uveitis requiring chronic corticosteroid treatment (oral prednisone 10 to 35 mg/day) at baseline to control their disease. Patients subsequently underwent a mandatory taper schedule, with complete corticosteroid discontinuation by Week 19.

Study M11-327 evaluated the long-term safety and efficacy of adalimumab 40 mg every other week in the treatment of uveitis, during which corticosteroid/immunosuppressant treatments could be initiated, maintained, escalated, tapered, or discontinued as needed.

## **Study Results**

### **Clinical Responses**

Results from both studies demonstrated statistically significant reduction of the risk of treatment failure over the course of the study in patients treated with adalimumab versus patients receiving placebo (**Table 52, Figure 6, Figure 7**).

**Table 52. Time to Treatment Failure in Uveitis Studies**

<b>Analysis Treatment</b>	<b>N</b>	<b>Failure N (%)</b>	<b>Median Time to Failure (Weeks/Months)</b>	<b>HR<sup>a</sup></b>	<b>CI 95% for HR<sup>a</sup></b>	<b>P value<sup>b</sup></b>
<b>Time to Treatment Failure At or After Week 6 in Study M10-877</b>						
Primary analysis (ITT)						
Placebo	107	84 (78.5)	13.0/3.0	-	-	-
Adalimumab	110	60 (54.5)	24.4/5.6	0.50 <sup>b</sup>	0.36, 0.70 <sup>b</sup>	< 0.001
<b>Time to Treatment Failure At or After Week 2 in Study M10-880</b>						
Primary analysis (ITT)						
Placebo	111	61 (55.0)	36.1/8.3	-	-	-
Adalimumab	115	45 (39.1)	NE <sup>c</sup>	0.57 <sup>b</sup>	0.39, 0.84 <sup>b</sup>	0.004
<p>Note: Treatment failure at or after Week 6 (Study M10-877), or at or after Week 2 (Study M10-880), was counted as event.</p> <p>Drop outs due to reasons other than treatment failure were censored at the time of dropping out.</p> <p>a. HR of adalimumab vs placebo from proportional hazards regression with treatment as factor.</p> <p>b. 2-sided P Value from log rank test.</p> <p>c. NE = not estimable. Fewer than half of at-risk subjects had an event.</p>						

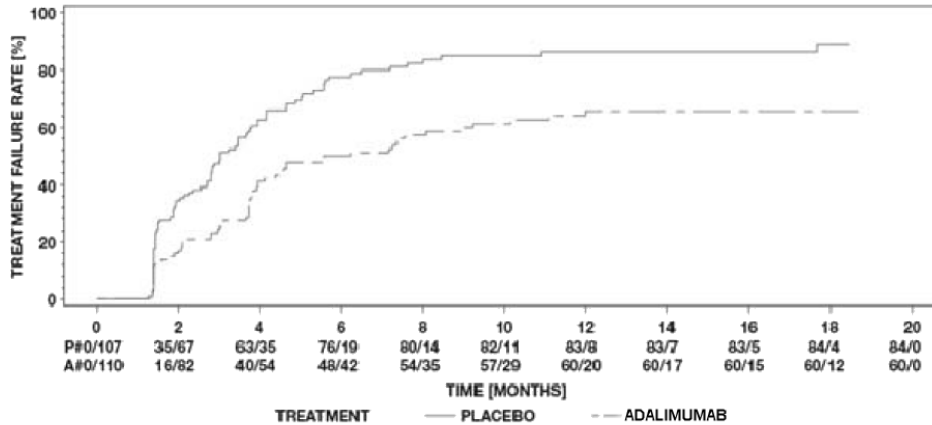

Note: P# = Placebo (Number of Events/Number at Risk); A# = adalimumab (Number of Events/Number at Risk)

**Figure 6. Kaplan-Meier Curves Summarizing Time to Treatment Failure on-or-after Week 6 (Study M10-877)**

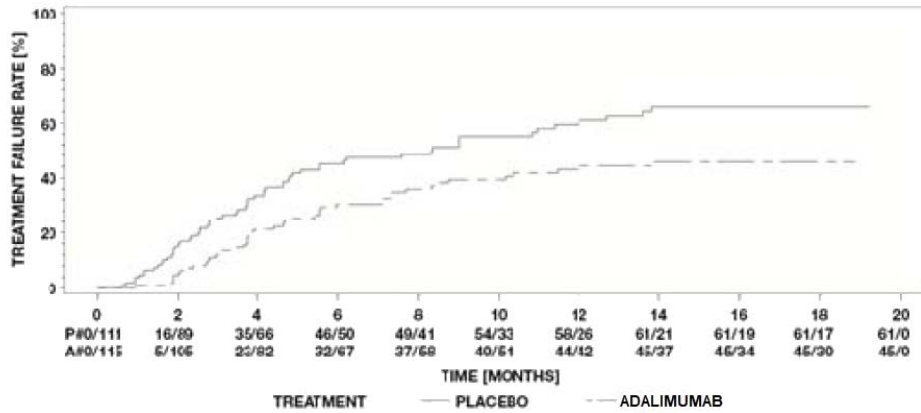

Note: P# = Placebo (Number of Events/Number at Risk); A# = adalimumab (Number of Events/Number at Risk)

**Figure 7. Kaplan-Meier Curves Summarizing Time to Treatment Failure on-or-after Week 2 (Study M10-880)**

In both studies, all components of the primary endpoint contributed cumulatively to the overall difference between adalimumab and placebo groups.

## Pediatric

### Polyarticular Juvenile Idiopathic Arthritis

#### Study Demographics and Trial Design

The safety and efficacy of adalimumab was assessed in two studies (Studies DE038 and M10-444) in children with active polyarticular or polyarticular course juvenile idiopathic arthritis, who had a variety of JIA onset types (most frequently rheumatoid-factor negative or positive

polyarthritis and extended oligoarthritis).

**Table 53** summarizes the clinical trials that were done in patients with polyarticular JIA.

**Table 53. Summary of Clinical Trial Evaluating Safety and Efficacy in Patients with Polyarticular Juvenile Idiopathic Arthritis**

Study #	Trial Design	Dosage, Route of Administration and Duration	Study Subjects (n)	Mean age (Range) (Years)	Gender (% Female)
DE038 (JIA I)	Multicenter, double-blind, randomized, placebo-controlled, open-label extension	<u>OL LI Phase</u> 24 mg adalimumab/m <sup>2</sup> BSA (up to a maximum of 40 mg total body dose) subcutaneous eow	171	11.3 ± 3.53 (4 to 17)	78.9%
		<u>DB Phase</u> 24 mg adalimumab/m <sup>2</sup> BSA (up to a maximum of 40 mg total body dose) subcutaneous eow or Placebo subcutaneous eow	133	11.6 ± 3.61 (4 to 17)	77.4%
		<u>OLE BSA Phase</u> 24 mg adalimumab/m <sup>2</sup> BSA (up to a maximum of 40 mg total body dose) subcutaneous eow	128	12.0 ± 3.59 (4 to 18)	76.6%
		<u>OLE FD Phase</u> 20 mg adalimumab subcutaneous eow, < 30 kg body weight or 40 mg adalimumab subcutaneous eow, ≥ 30 kg body weight	106	13.7 ± 3.82 (6 to 20)	73.6%
M10-444 (JIA II)	Multicenter, open-label	24 mg adalimumab/m <sup>2</sup> BSA (up to a maximum of 20 mg total body dose) subcutaneous eow	32	3.04 ± 0.723 (2.0 to 4.6)	87.5%
Definition(s): BSA = body surface area; DB = double blind; eow = every other week; OL BSA = open-label body surface area; OL FD = open-label fixed dose; OL LI = open-label lead in; SC = subcutaneous.					

### **Study DE038**

The safety and efficacy of adalimumab were assessed in a multicentre, randomized, double-blind, parallel-group study in 171 pediatric patients (4 to 17 years old at the time of enrollment) with moderate or severe polyarticular juvenile idiopathic arthritis (JIA). In the open-label lead in phase (OL LI) patients were stratified into two groups, methotrexate (MTX)-treated or non-MTX-treated. Patients who were in the non-MTX stratum were either naïve to or had been withdrawn from MTX at least two weeks prior to study drug administration. Patients remained on stable doses of NSAIDs and or prednisone (≤ 0.2 mg/kg/day or 10 mg/day maximum). In the OL LI phase all patients received 24 mg/m<sup>2</sup> up to a maximum of 40 mg adalimumab every other week for 16 weeks. The distribution of patients by age and minimum, median and maximum dose received during the OL LI phase is presented in **Table 54**.

**Table 54. Distribution of Patients by Age and adalimumab dose received during the OL LI phase**

Age Group	Number of patients at Baseline n (%)	Minimum, median and maximum dose
4 to 7 years	31 (18.1)	10, 20 and 25 mg
8 to 12 years	71 (41.5)	20, 25 and 40 mg
13 to 17 years	69 (40.4)	25, 40 and 40 mg

Patients demonstrating a Pediatric ACR 30 response at Week 16 were eligible to be randomized into the double blind (DB) phase and received either adalimumab 24 mg/m<sup>2</sup> up to a maximum of 40 mg, or placebo every other week for an additional 32 weeks or until disease flare. Disease flare criteria were defined as a worsening of  $\geq 30\%$  from baseline in  $\geq 3$  of 6 Pediatric ACR core criteria,  $\geq 2$  active joints, and improvement of  $> 30\%$  in no more than 1 of the 6 criteria.

After 32 weeks or at disease flare, patients were eligible to enroll into the open label extension phase.

The primary efficacy variable was the proportion of patients in the non-MTX stratum who experienced disease flare in the double-blind phase. Key secondary endpoints were analysis and comparison of disease flare at Week 48 including the proportion of patients with disease flare in those treated with MTX, time to onset (from double blind Baseline) of flare for patients in the non-MTX stratum, and time to onset (from double blind Baseline) of flare for patients treated with MTX. Subjects were clinically assessed at baseline, and for clinical response to adalimumab at Weeks 2, 4 and then every 4 weeks up to Week 48 or at early termination and throughout the OLE phases.

### **Study M10-444**

The safety and efficacy of adalimumab was assessed in an open-label, multicenter study in 32 children (2 to <4 years old or aged 4 and above weighing <15 kg) with moderately to severely active polyarticular JIA. The primary objective of the study was the evaluation of safety. The patients received 24 mg/m<sup>2</sup> body surface area (BSA) of adalimumab up to a maximum of 20 mg every other week as a single dose via SC injection for at least 24 weeks up to a maximum of 120 weeks duration. During the study, most subjects used concomitant MTX, with fewer reporting use of corticosteroids or NSAIDs.

### **Study Results**

**Table 55. Major Efficacy Results in the JIA Study (DE038)**

Stratum	Methotrexate		Without Methotrexate	
Phase				
OL-LI 16 weeks				
Ped ACR 30 response* (n/N)	94.1% (80/85) N=85*		74.4% (64/86) N=86*	
Double Blind	Adalimumab (N=38)	Placebo (N=37)	Adalimumab (N=30)	Placebo (N=28)
Disease flares at the end of 32 weeks (n/N)	36.8% (14/38)	64.9% (24/37)	43.3% (13/30)	71.4% (20/28) <sup>a</sup>

Median time to disease flare	>32 weeks	20 weeks	>32 weeks	14 weeks
<sup>a</sup> p = 0.031 * N and PedACR30 response rates are from the Open-Label Lead-In phase prior to the randomization to the Double-Blind phase.				

Twelve patients were treated for 6 years or longer.

The percentage of patients achieving PedACR30 responses were higher (94% vs. 74%) and, fewer patients developed antibodies (5.9% vs. 25.6%) when treated with the combination of adalimumab and MTX compared to adalimumab monotherapy. Therefore, adalimumab is recommended for use in combination with MTX, and for use as monotherapy only in patients for whom MTX use is not appropriate.

## 18 NON-CLINICAL TOXICOLOGY – REFERENCE BIOLOGIC DRUG

### Acute Toxicity – Single-Dose Studies

Three single-dose toxicity studies (two in mouse and one in rat) were conducted to obtain the qualitative and quantitative information about the acute toxicity profile of adalimumab after single intravenous administration.

In a mouse study, a single dosage of adalimumab (898 mg/kg) or vehicle control (phosphate buffered saline, PBS) was administered via a tail vein (5/sex/group). The animals were examined for clinical signs for 14 days after treatment. Necropsy was performed 14 days after treatment.

At the highest technically feasible dosage of 898 mg/kg adalimumab based on a 10 mL/kg injection volume and the highest available drug concentration, no deaths occurred. No clinical sign was observed that could be attributed to adalimumab. Body weight gains of the drug treated mice were comparable to those of the control mice. Pathomorphology did not reveal any toxicologically relevant change. The minimal lethal dosage of adalimumab in mice is greater than 898 mg/kg.

A second single-dose study was done in mice and included an investigation of the formation of MAHAs. Four groups of mice (5/sex/group) were included in this study. The animals were treated intravenously with either a single dosage of vehicle (PBS), or 1.6 mg/kg, 16 mg/kg, or 786 mg/kg of adalimumab (drug substance batch AFP603). Clinical signs, especially the hair coat, were assessed. Blood samples were collected before treatment and at Weeks 3, 5, 7, 9, 11, and 13 after drug administration to determine the adalimumab concentration in serum with an ELISA and to detect MAHA formation with two different ELISA techniques. All animals were sacrificed and subjected to gross examination upon termination of the study. Spleen and skin were evaluated histopathologically.

The general deportment of the mice and the body weight gains were not affected by treatment with adalimumab. One male at 1.6 mg/kg died on Day 13 during blood sampling under halothane anesthesia. The death of this animal was considered to be associated with the halothane anesthesia and not associated with the adalimumab treatment. Local hair loss in the nasolabial area associated with loss of tactile hairs was observed in all females at 1.6 mg/kg and four out of five females in the control group from Week 5 onwards. The results indicate that

the hair loss is not associated with adalimumab treatment since the same effect also was observed in the control mice.

The serum concentration curve of adalimumab was plotted for one mouse from each group. In the control and 1.6 mg/kg groups, the adalimumab serum concentration was always less than 0.6 mcg/mL, whereas at 16 mg/kg group, 70 mcg/mL was found at Week 3. No adalimumab was detected from Week 5 onwards at this dose. At 786 mg/kg group, a concentration as high as 484 mcg/mL was found at Week 3 and a measurable concentration of adalimumab was found up to nine weeks post injection.

The time course of MAHA development also was measured in one mouse from each group. MAHAs were not detected in the control mouse or any pre-treatment sample. Using a double sandwich (double antigen) MAHA assay (called MAHA-1 assay in the report) sensitive to inhibition by adalimumab in the blood, MAHAs were detected as early as Week 5 for the mouse treated at 1.6 mg/kg and not detected until Week 11 for the mouse treated at 16 mg/kg, whereas MAHAs were not detected at any time point for the mouse treated at 786 mg/kg, which was attributed to the assay interference by the high concentrations of circulating adalimumab. Using a direct capture (sandwich) MAHA assay (called MAHA-2 assay in the report) that is less sensitive to adalimumab interference, MAHAs were detected from Week 5 onwards in mice at 1.6 mg/kg and 16 mg/kg and at Weeks 9 and 13 in the 786 mg/kg mouse. Once the kinetics and titers were determined from the sample mouse of each group, MAHAs in all mice treated with adalimumab were analyzed at a dilution of 1:1000 at Week 5 for the 1.6 mg/kg and 16 mg/kg mice, and at Week 13 for the 786 mg/kg mice by the direct capture MAHA assay. MAHAs were detected in all samples, indicating that all the adalimumab-treated mice were MAHA positive after a single intravenous injection.

In the rat single-dose study, a single dosage of adalimumab (898 mg/kg, drug substance batch AF601-Ex pool) or vehicle control (PBS) was administered via a tail vein (5/sex/group). The animals were examined for clinical signs for 14 days after drug administration. Necropsy was performed 14 days after treatment.

At the highest technically feasible dosage of 898 mg/kg adalimumab based on a 10 mL/kg injection volume and the highest available drug concentration, no deaths occurred. Drug-related clinical signs were not observed. Body weight gains of the drug-treated rats were comparable to those of the control rats. Necropsy showed slightly to moderately enlarged spleens in three males at 898 mg/kg, and slightly enlarged spleens in three males in the control group. Histopathology of the enlarged spleens revealed moderate to marked extramedullary hematopoiesis. These changes were not attributed to the drug treatment because they were observed in the control group as well as in the treatment group.

In summary, adalimumab is well tolerated at the highest technically feasible dose and the minimal lethal dose after a single intravenous injection is greater than 898 mg/kg in mice and rats. Adalimumab is immunogenic in mice after a single intravenous dose.

### **Long-Term Toxicity – Multiple-Dose Studies** **Mouse (Four-Week Study)**

In a four-week mouse study, the mice were randomly distributed into three study groups. The highest dose in this study provided 16 times the maximum dosage of 10 mg/kg used in early

clinical studies.

The mice were intravenously administered either vehicle control (PBS) or adalimumab (drug substance batch AFP603) once per week on days 1, 8, 15, 22, and 29. The main study group was terminated on Day 30 and the recovery study group was allowed to recover for four weeks without further treatment after the last dose. The mice were observed for drug-related clinical signs at least once daily. Body weight and food consumption was recorded once weekly. Blood samples (0.3 mL) in the main and recovery study groups were collected from the retro-orbital venous plexus under light ether anesthesia on Days 30 and 57 (recovery group only) from mice chosen for hematology, clinical biochemistry and immunogenicity analyses.

There was no clinical sign of toxicity or behavioral changes related to drug treatment. Body weight and body weight gain of drug-treated animals remained in the same range as controls over the treatment and recovery periods.

The results of the toxicokinetic evaluation, using adalimumab level values from pooled serum, revealed that weekly iv administrations of 32, 70.9 and 157.2 mg/kg of adalimumab to mice for four weeks resulted in an increase of serum  $C_{max}$  and AUC values ( $C_{max}$ : 1193, 1528, 4231 mcg/mL in males, 794, 2069, 5028 mcg/mL in females; AUC: 66782, 104612, 190342 mcg•h/mL in males, 81598, 120693, 240366 mcg•h/mL in females). A slightly lower terminal half-life was observed for male mice than for female mice (97 to 112 hours versus 134 to 259 hours). The AUC values increased in a slightly less than proportional manner and were somewhat higher in female mice. There was, however a high degree of variability in the data.

Significant formation of MAHAs was detected in male and female mice in all drug-treated groups starting on the 8th day after the first administration. The level of MAHAs increased with subsequent doses. Significant differences were observed between 32.0 mg/kg and 70.9 mg/kg dosages ( $p < 0.01$ ) and the 32.0 mg/kg and 157.2 mg/kg dosages ( $p < 0.01$ ), but not between the 70.9 mg/kg and 157.2 mg/kg dosages ( $p > 0.05$ ). This indicates that the MAHAs are detected at all dose levels. Whether the differences between dose levels are due to assay interference or true differences in immunogenicity can not be determined.

### **Monkey (Four-Week Study)**

A four-week study was performed to investigate the potential toxicity of adalimumab in *cynomolgus* monkeys. A total of 32 monkeys (16 males and 16 females) were distributed randomly into four dosage groups, and were administered either the vehicle control (PBS), or adalimumab at 32, 70.9, or 157.2 mg/kg (drug substance batch AFP603) via intravenous injection (*vena saphena magna* of the right or left hind leg). The injections were given once per week on days 1, 8, 15, 22, and 29 for a total of five doses.

The toxicokinetic results showed a dose-proportional increase of serum maximum concentration ( $C_{max}$ ) of adalimumab and serum AUC. The central volume of distribution ( $V_c = \text{dose} / C_{(0)}$ ) was  $39.7 \pm 7.9$  mL/kg (mean  $\pm$  standard deviation). The AUCs corresponding to single-dose amounts of 32, 70.9, and 157.2 mg/kg, were  $201317 \pm 88835$ ,  $359667 \pm 127283$  and  $808900 \pm 200581$  mcg•h/mL, respectively. The terminal half-life was  $13.5 \pm 4.6$  days and the clearance was  $0.20 \pm 0.07$  mL/h/kg. No sex dependency of pharmacokinetic parameters and no influence of dose on total clearance were noted.



Immunohistochemistry data showed a minimal decrease of CD21<sup>+</sup> B-cells in the spleen follicles of the male monkeys treated with 70.9 and 157.2 mg/kg.) A reduced cytoplasmic immunostaining of IgG and IgM was also observed in the germinal centers of the follicles in most treated monkeys at all doses. No such change was observed in the follicles in the lymph nodes. All these changes were very subtle and generally reversible. Therefore, these changes were considered to be the result of pharmacologically functional effects of adalimumab rather than toxicological effects. No deposits of immune-complexes were found in kidney, lung, liver, skin, spleen, thymus, lymph nodes, skeletal muscle, and heart.

### **Monkey (39-Week Study)**

A 39-week study in *cynomolgus* monkeys was done to evaluate the potential toxicity and reversibility of any toxic effect of adalimumab. A total of 32 animals (16 males and 16 females) were randomly distributed into four groups, and were administered either vehicle control (PBS buffer) or adalimumab at 32, 82.9, or 214.8 mg/kg. The test article or control agent was administered by intravenous injection into a vena saphena magna, once per week for 39 weeks (total of 40 injections).

There were no significant differences in clinical signs of toxicity or behavior and food consumption over the treatment and recovery periods in the drug-treated groups as compared to the control animals. Body weights of the animals treated with 32 and 82.9 mg/kg were not affected as compared with the control animals. In the 214.8 mg/kg group, a slight, transient decrease in the body weight was observed in test Week 4, and completely recovered from test Week 6 onwards. The body weights of the female animals in this group were decreased slightly from test Week 2 onwards. The decreases were not statistically significant at  $p \leq 0.01$  as compared with the control animals and were within the normal fluctuation of body weight.

The examination of immune complexes showed a reduced antigen expression of IgG and IgM in the follicular dendritic cells of the spleen in all drug-treated monkeys. Concomitantly, the follicular dendritic cells were reduced in number and the normally dense network was altered. In parallel, the IgG or IgM positive plasma cell count increased slightly in the spleen independently of the different compartments. These changes were considered to be the pharmacologically functional effects of adalimumab rather than toxicological effects.

Toxicokinetic results reported in Report No. MPF/EBB 9741 showed an increase of steady-state serum concentrations and AUC values. At dosages of 32, 82.9, and 214.8 mg/kg of adalimumab, the corresponding  $C_{max}$  (mean  $\pm$  standard deviation) at five minutes after the last administration were  $2731 \pm 467$ ,  $6527 \pm 2450$ ,  $13563 \pm 1740$  mcg/mL and the corresponding serum AUCs were  $304774 \pm 74634$ ,  $617368 \pm 233959$ , and  $1299965 \pm 228114$  mcg•h/mL, respectively. The corresponding clearances were  $0.11 \pm 0.04$ ,  $0.16 \pm 0.07$ , and  $0.17 \pm 0.03$  mL/h/kg, respectively. The terminal half-life, evaluated from data obtained during the recovery phase of two male and two female monkeys, was  $16.2 \pm 3.4$  days. No sex dependency of pharmacokinetic parameters and no influence of dose on the clearance were noted.

The distribution of adalimumab in the vascular compartment was broad in the lungs, liver, and skin at 214.8 mg/kg. Cartilage staining in the bronchi with anti-adalimumab antibodies was observed in several treated monkeys at 32 mg/kg onwards. In the synovial membrane, adalimumab was detected in the vascular compartment mainly at 214.8 mg/kg, and additionally in one male monkey at 82.9 mg/kg.

Most of the immunohistochemical changes observed in kidneys, spleen, and lungs were found to be reversible. However, the cellular diminution in the thymus in males was partially reversed, and did not reach the cellularity of the control animals after a 20-week recovery period. No adalimumab could be detected after the 20-week recovery period in the vessels of the organs and tissues examined.

### **Mutagenicity and Carcinogenicity**

No carcinogenicity study was performed for adalimumab.

#### **In vitro Genotoxicity**

The mutagenic potential of adalimumab was tested in the Ames test and in the *Escherichia coli* reverse mutation assay. These tests are based on the ability of the test article to induce reverse mutations in selected loci of bacteria. *Salmonella typhimurium* strains TA 98, TA 100, TA 1535, and TA 1537, as well as *Escherichia coli* strain WP2 uvrA were used. Adalimumab (drug substance batch AF601-Ex pool) was tested at concentrations of 0, 20, 100, 500, 2500 and 5000 mcg/plate. Three plates were used per dose. Positive controls and a vehicle control (PBS buffer) were included in each experiment. Both the standard plate test (Ames test) and preincubation test with and without the addition of an exogenous metabolic activation system (S-9 fraction prepared from the livers of Aroclor 1254 treated rats) were performed. The results were considered positive if the revertant rate of a treatment group was at least twice that of the spontaneous revertant rate (vehicle control), a dose-response relationship occurred, and the experiments were reproducible.

No bacteriotoxic effect, such as reduced His<sup>-</sup> or Trp<sup>-</sup> background growth and decreased number of His<sup>+</sup> or Trp<sup>+</sup> revertants, were observed in adalimumab-treated plates when compared to the vehicle control. There was no increase in the number of mutant colonies under any experimental conditions in any strain of bacteria for the test article, whereas the positive controls showed the expected response when compared to the vehicle control. Therefore, the test substance is not mutagenic either in the Ames test or in the *E. coli* reverse mutation assays.

#### **In vivo Genotoxicity**

The potential clastogenic and spindle poison effects of adalimumab were tested in an in vivo micronucleus assay in NMRI mice after a single intravenous dose. The mice were randomly allocated into eight groups: two vehicle control groups (five mice/sex/group), four treatment groups (five mice/sex/group), and two positive control groups (five mice/group). The mice were intravenously treated once either with the vehicle control (PBS buffer); 224.5, 449.0, or 898 mg/kg (two groups) of adalimumab (drug substance batch AF601-Ex pool); or positive controls of 20 mg cyclophosphamide (two male and three female) or 0.15 mg/kg vincristine (three male and two female). All animals were sacrificed 24 hours after treatment except for one vehicle control group and one 898 mg/kg group, which were sacrificed 48 hours after dosing.

Bone marrow slides were prepared and stained with eosin and methylene solution, followed by Giemsa stain. The slides were examined microscopically for the following parameters: number of polychromatic erythrocytes (PCE), number of PCE containing micronuclei (MN), number of normochromatic erythrocytes (NCE), number of NCE containing MN, number of small micronuclei, and number of large micronuclei. The ratio of PCE to NCE was calculated. The

results were considered positive if the following criteria were met: a dose-related and significant increase in the number of micronucleated PCE at the 24-hour and/or 48-hour intervals, and the proportion of cells containing micronuclei exceeded both the values of the concurrent negative control range and the negative historical control range.

The number of PCE and NCE containing MN in the adalimumab-treated groups was not significantly different from the concurrent, negative controls at any of the sacrificed intervals. However, the percentage of small MN in PCE in the cyclophosphamide-treated group and the percentage of large MN in PCE in the vincristine-treated group increased significantly as compared with the vehicle control. The ratio of PCE to NCE in all dose groups was always in the same range as that of the control values, suggesting normal erythropoiesis.

The results indicate that adalimumab does not have clastogenic activity or spindle poison effects. Also, no inhibition of erythropoiesis induced by the treatment with adalimumab was observed in NMRI mice.

### **Reproduction and Teratology**

In pregnant monkeys adalimumab was distributed into the serum of the fetus and into the amnion fluid showing a distribution pattern that would be expected of a human IgG in a pregnant woman. No drug-related toxicity was observed. Distribution of adalimumab into the milk was not determined.

## **19 SUPPORTING PRODUCT MONOGRAPHS**

1. PrHUMIRA®, Product Monograph, Control number: 225872; Dated: June 25, 2019, AbbVie Corporation

## READ THIS FOR SAFE AND EFFECTIVE USE OF YOUR MEDICINE

### PATIENT MEDICATION INFORMATION

**HYRIMOZ<sup>®</sup>** (pronounced <hye ri' moze>)  
**(adalimumab)**

**20 mg / 0.4 mL Single-use Prefilled Syringe with Needle Guard**

Read this carefully before you start taking **HYRIMOZ** and each time you get a refill. This leaflet is a summary and will not tell you everything about this drug. Talk to your healthcare professional about your medical condition and treatment and ask if there is any new information about **HYRIMOZ**.

**HYRIMOZ** is a biosimilar biologic drug (biosimilar) to the reference biologic drug HUMIRA<sup>®</sup>. A biosimilar is authorized based on its similarity to a reference biologic drug that was already authorized for sale.

#### Serious Warnings and Precautions

- **Allergic reactions:** If you/your child develop a severe rash, swollen face or difficulty breathing while taking HYRIMOZ, call your/your child's doctor right away.
- **Hepatosplenic T-cell lymphoma:** Very rare reports of hepatosplenic T-cell lymphoma (HSTCL), a rare serious lymphoma that is often fatal, have been identified in patients treated with adalimumab. Most patients had also been treated with other medications for Crohn's disease and the majority were in adolescent and young adult males. The link between HSTCL and adalimumab is not clear.
- **Other cancers:** There have been very rare cases of certain kinds of cancer in patients taking adalimumab or other TNF-blockers. Some patients receiving adalimumab have developed types of cancer called non-melanoma skin cancer. Tell your/your child's doctor if you/your child have a bump or open sore that does not heal. People with more serious rheumatoid arthritis that have had the disease for a long time may have a higher than average risk of getting a kind of cancer that affects the lymph system, called lymphoma. If you/your child take HYRIMOZ or other TNF-blockers, your/your child's risk may increase. There have been cases of lymphoma and other cancers, including unusual types, in children, adolescents and young adults taking TNF-blocking agents, including adalimumab, which sometimes resulted in death. For children and adults taking TNF-blocker medicines, the chances of developing lymphoma or other cancers may increase.
- **Lupus-like symptoms:** Some patients have developed lupus-like symptoms that got better after their treatment was stopped. If you/your child have chest pains that do not go away, shortness of breath, joint pain or a rash on your/your child's cheeks or arms that gets worse in the sun, call your/your child's doctor right away. Your/your child's doctor may decide to stop your/your child's treatment.

- **Nervous system diseases:** There have been rare cases of disorders that affect the nervous system of people taking adalimumab or other TNF-blockers. Signs that you/your child could be experiencing a problem affecting your/your child's nervous system include: numbness or tingling, problems with your/your child's vision, weakness in your/your child's legs, and dizziness.
- **Serious infections:** There have been rare cases where patients taking adalimumab or other TNF-blocking agents have developed serious infections. Some of these cases have been life-threatening. Such infections include tuberculosis, infections caused by bacteria or fungi, and bacterial infections that have spread throughout the body (sepsis). Infection causes include tuberculosis, legionellosis (a serious form of bacterial pneumonia), listeriosis (an infection that usually develops after eating food contaminated by bacteria called listeria), and very rare cases of hepatitis B infection relapse.
- **Blood problems:** In some instances, patients treated with TNF-blocking agents may develop low blood counts, such as anemia (low red blood cells) or low platelets. If you/your child develop symptoms such as persistent fever, bleeding, or bruising, you should contact your/your child's doctor right away.

#### What is HYRIMOZ used for?

**HYRIMOZ treatment should be started and supervised by specialist physicians experienced in the diagnosis and treatment of rheumatoid arthritis (RA), polyarticular juvenile idiopathic arthritis (JIA), psoriatic arthritis (PsA), ankylosing spondylitis (AS), adult Crohn's disease (CD), ulcerative colitis (UC), hidradenitis suppurativa (HS), psoriasis (Ps) or adult uveitis, and familiar with the HYRIMOZ efficacy and safety profile.**

HYRIMOZ is a medicine that is used in:

- adults with rheumatoid arthritis, which is an inflammatory disease of the joints.
- adults with psoriatic arthritis, which is an inflammatory disease of the joints and skin.
- adults with ankylosing spondylitis, which is a form of arthritis.
- adults with Crohn's disease, which is an inflammatory disease of the digestive tract.
- patients 2 years of age and older who have polyarticular juvenile idiopathic arthritis.
- adults with ulcerative colitis, which is an inflammatory disease of the bowel (colon).
- adults with moderate to severe hidradenitis suppurativa (HS) who have not responded to antibiotics. HS is a painful, progressive, chronic inflammatory skin disease that causes nodules, abscesses, sinus tracts and fistulas under the breasts, underarms, buttocks and groin.
- adults with psoriasis, which is an inflammatory disease of the skin. The doctor prescribed HYRIMOZ to reduce the signs and symptoms of your plaque psoriasis.
- adults with uveitis, which is an inflammatory disease of the eye.

Patients with rheumatoid arthritis, polyarticular juvenile idiopathic arthritis, psoriatic arthritis, ankylosing spondylitis, hidradenitis suppurativa, psoriasis, or uveitis may be given other

medicines for their disease before they are given HYRIMOZ. If you have ulcerative colitis or you have Crohn's disease, you will first be given other medicines. If you do not respond well enough to these medicines, you will be given HYRIMOZ to reduce the signs and symptoms of your/your child's disease.

### **How does HYRIMOZ work?**

HYRIMOZ is a fully human monoclonal antibody produced by cultured cells. Monoclonal antibodies are proteins that recognize and bind to other unique proteins. HYRIMOZ binds to a specific protein called TNF-alpha (also known as tumor necrosis factor). People with rheumatoid arthritis, psoriatic arthritis, ankylosing spondylitis, Crohn's disease, ulcerative colitis, hidradenitis suppurativa or psoriasis have too much of TNF-alpha in their bodies. The extra TNF-alpha in your/your child's body can attack normal healthy body tissues and cause inflammation, especially in the tissues of your bones, cartilage, joints, digestive tract and skin. By binding to TNF-alpha, HYRIMOZ decreases the inflammation process of these diseases.

HYRIMOZ helps reduce the signs and symptoms of rheumatoid arthritis, polyarticular juvenile idiopathic arthritis and psoriatic arthritis (such as pain and swollen joints), may help improve your/your child's ability to perform daily activities (such as getting dressed, walking and climbing stairs), and may help prevent further damage to your/your child's bones and joints. In addition, HYRIMOZ helps reduce the signs and symptoms of ankylosing spondylitis (back pain and morning stiffness), and adult Crohn's disease or ulcerative colitis (abdominal pain and diarrhea).

HYRIMOZ is also used to treat inflammatory lesions (nodules and abscesses) in adult patients with hidradenitis suppurativa.

HYRIMOZ also helps reduce the signs and symptoms of psoriasis (such as pain, itching and scaly patches on skin).

HYRIMOZ helps control uveitis by reducing the risk of inflammation and loss of vision in adult patients.

HYRIMOZ, however, can also lower your/your child's body's ability to fight infections. Taking HYRIMOZ can make you/your child more prone to getting infections or make any infection you/your child have worse.

### **What are the ingredients in HYRIMOZ?**

**Medicinal ingredient:** adalimumab

**Non-medicinal ingredients:** adipic acid, citric acid monohydrate, mannitol, polysorbate 80, sodium chloride and water for injection. Hydrochloric acid and sodium hydroxide are added as necessary to adjust pH.

### **HYRIMOZ comes in the following dosage forms:**

#### **Single-dose pre-filled HYRIMOZ SensoReady® Pen Injection:**

40 mg/0.8 mL of HYRIMOZ is provided by a single-dose pen (SensoReady® Pen), containing a 1 mL pre-filled glass syringe with a fixed 29-gauge, ½-inch needle and a black needle cover.

**Single-dose pre-filled syringe with BD UltraSafe Passive™ Needle Guard Injection:**

20 mg/0.4 mL of HYRIMOZ is provided by a single-dose, 1 mL pre-filled glass syringe with a needle guard and add-on finger flange, a fixed 29-gauge, ½-inch needle and a needle cover.

40 mg/0.8 mL of HYRIMOZ is provided by a single-dose, 1 mL pre-filled glass syringe with a needle guard and add-on finger flange, a fixed 29-gauge, ½-inch needle and a needle cover.

**Do not use HYRIMOZ if:**

You/your child should not take HYRIMOZ if you/your child have:

- an allergy to any of the ingredients in HYRIMOZ (see What are the ingredients in HYRIMOZ?).
- a serious infection such as tuberculosis, infections caused by bacteria or fungi, and bacterial infections that have spread throughout the body (sepsis).
- moderate to severe heart failure (NYHA class III/IV).

**To help avoid side effects and ensure proper use, talk to your healthcare professional before you take HYRIMOZ. Talk about any health conditions or problems you may have, including if:**

- you/your child have or have had any kind of infection including an infection that is in only one place in your/your child's body (such as an open cut or sore), or an infection that is in your/your child's whole body (such as the flu). Having an infection could put you/your child at risk for serious side effects from HYRIMOZ. If you are unsure, ask your/your child's doctor.
- you/your child have a history of infections that keep coming back or other conditions that might increase your/your child's risk of infections, including fungal infections.
- you/your child have ever had tuberculosis, or if you/your child have been in close contact with someone who has had tuberculosis. If you/your child develop any of the symptoms of tuberculosis (a dry cough that doesn't go away, weight loss, fever, night sweats) call your/your child's doctor right away. Your/your child's doctor will need to examine you/your child for tuberculosis and perform a skin test.
- you/your child resided or travelled to areas where there is a greater risk for certain kinds of infections such as tuberculosis, histoplasmosis, coccidioidomycosis, blastomycosis, or parasitic infections. These infections are caused by a bacteria or a fungus that can affect the lungs or other parts of your/your child's body. If you/your child take HYRIMOZ, these may become active or more severe. If you don't know if you/your child have lived in or travelled to an area where these infections are common, ask your/your child's doctor.
- you/your child have ever had liver injury or hepatitis B virus infection or are at risk of developing this infection. Signs and symptoms include the following: yellowing of the skin or eyes (jaundice), feeling of sickness, tiredness, loss of appetite, joint pain, fever, dark brown-coloured urine, vomiting, and abdominal pain. If you/your child experience any of these signs and symptoms, contact your/your child's doctor immediately. These symptoms may occur several months after starting therapy with HYRIMOZ.
- you/your child experience any numbness or tingling or have ever had a disease that affects your/your child's nervous system like multiple sclerosis or Guillain-Barré syndrome.
- you/your child have or have had heart failure.

- you/your child are scheduled to have major surgery or dental procedures.
- you/your child are scheduled to be vaccinated for anything. It is recommended that pediatric patients, if possible, be brought up to date with all immunizations according to current guidelines before starting HYRIMOZ.
- you/your child are taking other medicines for your/your child's rheumatoid arthritis, polyarticular juvenile idiopathic arthritis, psoriatic arthritis, ankylosing spondylitis, Crohn's disease, psoriasis, or other conditions. You/your child can take other medicines provided your/your child's doctor has prescribed them or has told you it is acceptable that you/your child take them while you/your child are taking HYRIMOZ. It is important that you tell your/your child's doctor about any other medicines you/your child are taking for other conditions (for example, high blood pressure medicine) before you/your child start taking HYRIMOZ.
- you/your child are taking other medicines for your/your child's Crohn's disease or other conditions. You/your child can take other medicines provided your/your child's doctor has prescribed them or has told you it is acceptable that you/ your child take them while you/your child are taking HYRIMOZ. It is important that you tell the doctor about any other medicines you/your child are taking for other conditions before you/your child start taking HYRIMOZ.
- you/your child are taking any over-the-counter drugs, herbal medicines and vitamin and mineral supplements.
- you/your child are pregnant or could become pregnant.
- you/your child are breast-feeding or plan to breast-feed

***If you are not sure or have any questions about any of this information, ask your/your child's doctor.***

**Other warnings you should know about:**

Before starting, during and after treatment with HYRIMOZ, you/your child should be checked for active or inactive tuberculosis infection with a tuberculin skin test.

Any medicine can have side effects. Like all medicines that affect your/your child's immune system, HYRIMOZ can cause serious side effects (see Serious Warnings and Precautions box).

If you/your child received HYRIMOZ while pregnant, your/her baby may be at higher risk for getting an infection for up to approximately five months after the last dose of HYRIMOZ received during pregnancy. It is important that you tell your/her baby's doctors and other healthcare professionals about your/her HYRIMOZ use during pregnancy so they can decide when your/her baby should receive any vaccine.

**Tell your healthcare professional about all the medicines you take, including any drugs, vitamins, minerals, natural supplements or alternative medicines.**

**The following may interact with HYRIMOZ:**

You/your child should not take HYRIMOZ with:

- other TNF-blockers such as etanercept (Enbrel<sup>®</sup>), infliximab (Remicade<sup>®</sup>), certolizumab pegol (Cimzia<sup>®</sup>), or golimumab (Simponi<sup>®</sup>)
- abatacept (Orencia<sup>®</sup>)



- anakinra (Kineret®)

If you have questions, ask your/your child's doctor.

### **How to take HYRIMOZ:**

#### **Usual dose:**

HYRIMOZ is administered by injection under the skin (by subcutaneous injection).

#### **Adults with Rheumatoid Arthritis, Psoriatic Arthritis or Ankylosing Spondylitis:**

- The recommended dose is 40 mg administered every other week as a subcutaneous injection.

#### **Patients, Aged 2 Years and Older, with Polyarticular Juvenile Idiopathic Arthritis:**

- weighing 10 kg to less than 30 kg: the recommended dose of HYRIMOZ is 20 mg every other week.
- weighing 30 kg or more: the recommended dose of HYRIMOZ is 40 mg every other week.

A dose of 10 mg every other week can be considered for patients weighing 10 to <15 kg. A different adalimumab product should be considered as there are no available presentations of HYRIMOZ capable of delivering 10 mg.

#### **Adults with Crohn's Disease or Ulcerative Colitis:**

- The recommended induction dose is 160 mg at Week 0 (dose can be administered as four injections in one day or as two injections per day for two consecutive days), followed by 80 mg at Week 2.
- The recommended maintenance dose regimen is 40 mg every other week beginning at Week 4.

#### **Adults with Hidradenitis Suppurativa:**

- The recommended initial dose is 160 mg, followed by 80 mg two weeks later. The first dose of 160 mg can be administered as four injections in one day or as two injections per day for two consecutive days. The second dose of 80 mg is given as two 40 mg injections in one day.
- The recommended maintenance dose regimen is 40 mg every week beginning four weeks after the initial dose.

#### **Adults with Psoriasis or Uveitis:**

- The recommended dose is an initial dose of 80 mg, followed by 40 mg given every other week starting one week after the initial dose.

### **Your HYRIMOZ single-dose pre-filled syringe with needle guard and add-on finger flange**

The following instructions explain how to inject HYRIMOZ. Please read the instructions carefully and follow them step-by-step. You will be instructed by your/your child's doctor or assistant on the technique of injection. Do not attempt to inject until you are sure that you understand how to

prepare and give the injection. After proper training, the injection can be self-administered or given by another person; for example, a healthcare professional, a family member or friend.

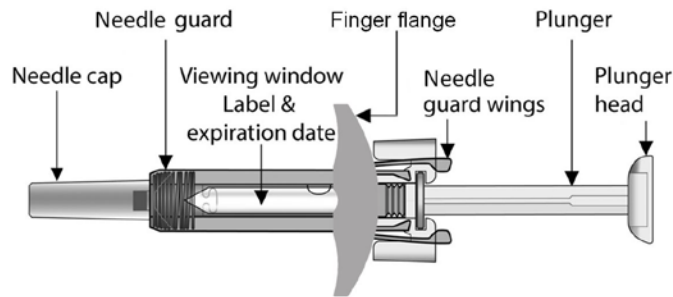

Figure A: HYRIMOZ pre-filled syringe with BD UltraSafe Passive™ Needle Guard and add-on finger flange

### What do you need for your injection?

Included in your HYRIMOZ pre-filled syringe carton is:

- a new HYRIMOZ pre-filled syringe (see Figure A). Each pre-filled syringe contains 20 mg/0.4 mL of HYRIMOZ.

Not included in you HYRIMOZ pre-filled syringe carton

- Alcohol swab
- Cotton ball or gauze
- Sharps disposal container

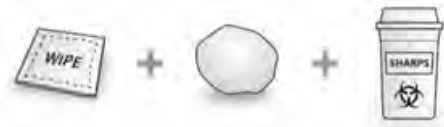

Figure B: items not included in the carton

See “4. Dispose of used HYRIMOZ single-dose pre-filled syringes” at the end of this Instructions for Use.

### Before your injection

#### Preparing the HYRIMOZ single-dose pre-filled syringe

- For a more comfortable injection, take the carton containing the HYRIMOZ pre-filled syringe out of the refrigerator and leave it unopened on your work surface for about 15 to 30 minutes so that it reaches room temperature.
- Wash your hands well with soap and water.
- Clean the injection site with an alcohol swab
- Remove the HYRIMOZ pre-filled syringe from the outer carton and take it out of the blister.
- Inspect the HYRIMOZ pre-filled syringe. Look through the viewing window. The liquid should be clear, colorless to slightly yellowish and may contain small, translucent or white floating particles of protein. Do not use if any other particulates and/or

discolorations are observed. If you are concerned with the appearance of the solution, then contact your pharmacist for assistance.

- **Do not use** the HYRIMOZ pre-filled syringe if it is broken or the needle guard is activated. Return the HYRIMOZ pre-filled syringe and the package it came in to the pharmacy.
- Look at the expiration date (EXP) on your HYRIMOZ pre-filled syringe. Do not use your HYRIMOZ pre-filled syringe if the expiration date has passed.

### 1. Choosing your injection site:

- The recommended injection site is the front of your thighs. You may also use the lower abdomen, but not the area 2 inches (5 cm) around your navel (belly button) (see Figure C).
- Choose a different site each time you give yourself an injection.
- Do not inject into areas where the skin is tender, bruised, red, scaly, or hard. Avoid areas with scars or stretch marks. If you have psoriasis, you should NOT inject directly into areas with psoriasis plaques

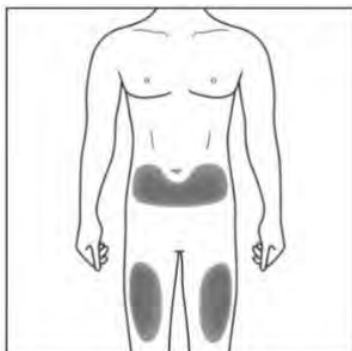

Figure C: choose your injection site

### 2. Cleaning your injection site:

- Using a circular motion, clean the injection site with a alcohol wipe. Leave it to dry before injecting (see Figure D).
- Do not touch the cleaned area before injecting



Figure D: clean your injection site

### 3. Giving your injection

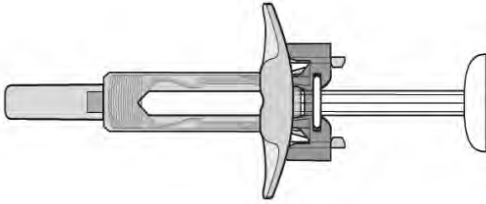

Figure E: needle guard is not activated – the single-dose pre-filled HYRIMOZ is ready for use

- In this configuration the needle guard is **NOT ACTIVATED**.
- The HYRIMOZ pre-filled syringe is ready for use (see Figure E).

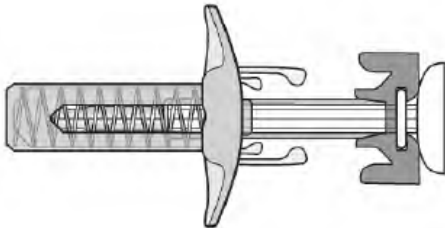

Figure F: needle guard is activated – do not use

- In this configuration the needle guard of your HYRIMOZ pre-filled syringe is **ACTIVATED**.
- **DO NOT USE** the pre-filled syringe (see figure F).
- Carefully pull the needle cap straight off to remove it from the single-dose pre-filled HYRIMOZ syringe (see *Figure G*).
- Discard the needle cap.
- You may see a drop of liquid at the end of the needle. This is normal.

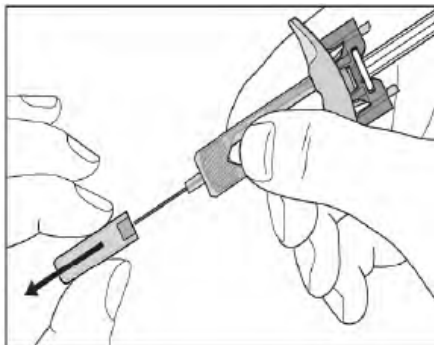

Figure G: pull the needle cap off

- Gently pinch the skin at the injection site (see Figure H).
- Insert the needle into your skin as shown.
- Push the needle all the way in to ensure that the medication can be fully administered

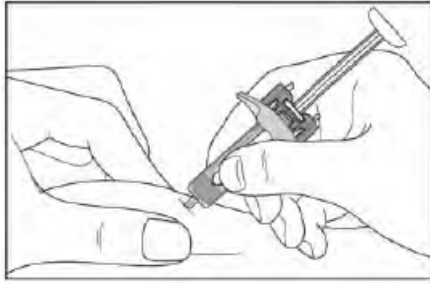

Figure H: insert the needle

- Hold the single-dose pre-filled HYRIMOZ syringe as shown (see *Figure I*).
- Slowly press down on the plunger as far as it will go, so that the plunger head is completely between the needle guard wings.
- Continue to press fully on the plunger for an additional 5 seconds. Hold the syringe in place for 5 seconds

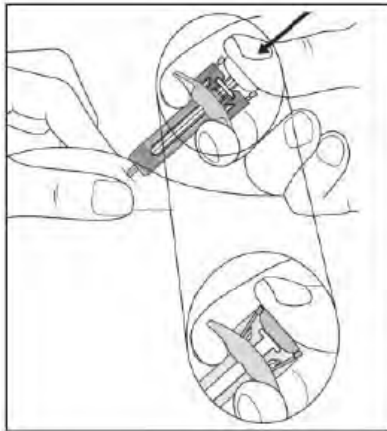

Figure I: hold the syringe

- **Keep the plunger fully pressed down** while you carefully lift the needle straight out from the injection site and let go off your skin (see *Figure J*).

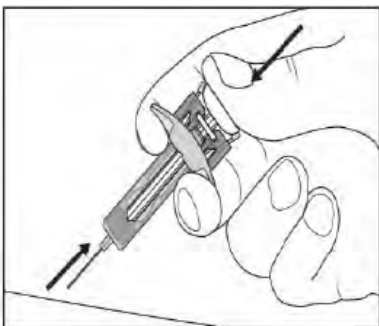

Figure J: lift the needle straight out

- Slowly release the plunger and allow the needle safety guard to automatically cover the exposed needle (see *Figure K*).
- There may be a small amount of blood at the injection site. You can press a cotton ball

or gauze onto the injection site and hold it for 10 seconds. Do not rub the injection site. You may cover the injection site with a small adhesive bandage, if needed

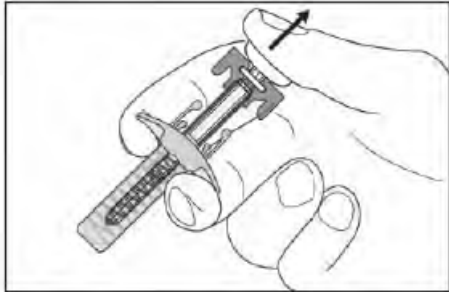

Figure K: slowly release the plunger

#### 4. Disposing of used single-dose pre-filled HYRIMOZ syringes

- Dispose of the used pens in a sharps container (closable, puncture-resistant container). For the safety and health of you and others, the pens must never be re-used.
- Do not throw away any medicines via wastewater or household waste. Ask your doctor or pharmacist how to throw away medicines you no longer use. These measures will help protect the environment. Any unused product or waste material should be disposed of in accordance with local requirements.

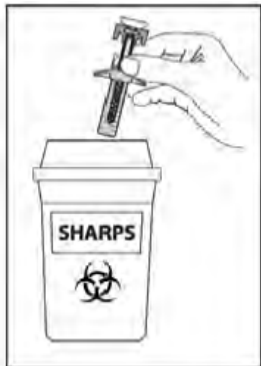

Figure L: dispose of your used pre-filled syringe

#### Overdose:

If you/your child accidentally inject HYRIMOZ more frequently than instructed, contact your/your child's doctor or local poison control centre right away.

If you think you have taken too much HYRIMOZ, contact your healthcare professional, hospital emergency department or regional poison control centre immediately, even if there are no symptoms.

#### Missed Dose:

If you/your child forget to give yourself/your child an injection, you/your child should inject the missed dose of HYRIMOZ as soon as you/your child remember. Then administer the next dose as you would have on the originally scheduled date.

## What are possible side effects from using HYRIMOZ?

These are not all the possible side effects you may feel when taking HYRIMOZ. If you experience any side effects not listed here, contact your healthcare professional.

Like all medicines, HYRIMOZ can cause side effects. Most side effects are mild to moderate. However, some may be serious and require treatment.

Tell your/your child's doctor immediately if you/your child experience any of the following:

- severe rash, hives or other signs of allergic reaction
- swollen face, hands, feet
- trouble breathing, swallowing
- sudden weight gain; this is possibly indicative of new or worsening heart failure
- bruising or bleeding very easily, looking very pale; this could mean a blood problem such as low red blood cells (anemia) or low platelets

Tell the doctor as soon as possible if you/your child notice any of the following:

- signs of infection such as fever, malaise, wounds, dental problems, burning on urination
- feeling weak or tired
- coughing
- tingling
- numbness
- double vision
- arm or leg weakness
- arm or leg pain, swelling or redness
- bump or open sore that does not heal
- red scaly patches or raised bumps that are filled with pus; this could be new or worsening hidradenitis suppurativa, new or worsening psoriasis or a skin infection
- alopecia (loss of hair)
- changes in the colour of the skin
- changes in the colour of your/your child's urine (dark or red)
- worsening of the appearance of a scar
- night sweats
- weight loss
- pain in the abdomen or chest

Serious side effects and what to do about them			
Symptom / effect	Talk to your healthcare professional		Stop taking drug and get immediate medical help
	Only if severe	In all cases	
<b>VERY COMMON</b> Injection site reaction		✓	
<b>COMMON</b> Cough and cold symptoms, including sore throat		✓	
Headache	✓		

Serious side effects and what to do about them			
Symptom / effect	Talk to your healthcare professional		Stop taking drug and get immediate medical help
	Only if severe	In all cases	
Rash		✓	
Nausea		✓	
Pneumonia		✓	✓
Fever		✓	
Abdominal pain	✓		
<b>UNCOMMON</b>			
Tuberculosis		✓	✓
Other serious infections		✓	✓
Nerve disorder		✓	✓
Appendicitis		✓	✓
Blood clots: abdominal pain, chest pain, leg or arm pain with redness and swelling		✓	✓
Bladder infection (painful urination)		✓	✓
Hepatitis (jaundice [yellow skin, dark urine], abdominal pain, tiredness)		✓	✓

If you have a troublesome symptom or side effect that is not listed here or becomes bad enough to interfere with your daily activities, talk to your healthcare professional.

### Reporting Side Effects

You can report any suspected side effects associated with the use of health products to Health Canada by:

- Visiting the Web page on [Adverse Reaction Reporting](http://www.hc-sc.gc.ca/dhp-mps/medeff/report-declaration/index-eng.php) (<http://www.hc-sc.gc.ca/dhp-mps/medeff/report-declaration/index-eng.php>) for information on how to report online, by mail or by fax; or
- Calling toll-free at 1-866-234-2345.

*NOTE: Contact your health professional if you need information about how to manage your side effects. The Canada Vigilance Program does not provide medical advice.*

### Storage:

Keep HYRIMOZ and all other medicines out of the reach of children.

Store between 2 and 8°C (in a refrigerator) in the original carton until ready to use. Do not freeze your HYRIMOZ pre-filled syringes. **DO NOT FREEZE HYRIMOZ.** Do not store your HYRIMOZ pre-filled syringes in extreme heat or cold. Protect from light. Refrigerated HYRIMOZ remains stable until the expiration date printed on the pre-filled syringe. Do not use beyond the expiration date.



When needed, for example when you/your child are travelling, a HYRIMOZ pre-filled syringe can be stored at room temperature (up to 25°C/77°F) for a single maximum period of 21 days.

Once taken out of the refrigerator for room temperature storage, a HYRIMOZ pre-filled syringe must be used within 21 days, even if it is put back in the refrigerator. If not used within 21 days, the HYRIMOZ pre-filled syringe must be discarded. You should record the date when the HYRIMOZ pre-filled syringe is first removed from the refrigerator.

Care should be taken to avoid dropping or crushing the product as it contains a glass syringe.

### **General Advice About Prescription Medicines**

Talk to your/your child's doctor or other healthcare provider if you have any questions about this medicine or your/your child's condition. Medicines are sometimes prescribed for purposes other than those listed in a **PATIENT MEDICATION INFORMATION** leaflet. If you have any concerns about this medicine, ask the doctor. The doctor or pharmacist can give you information about this medicine that was written for healthcare professionals. Do not use this medicine for a condition for which it was not prescribed. Do not share this medicine with other people.

**Keep HYRIMOZ and all medicines out of the reach of children.**

**If you want more information about HYRIMOZ:**

- Talk to your healthcare professional
- Find the full product monograph that is prepared for healthcare professionals and includes this Patient Medication Information by visiting the [Health Canada website](http://hc-sc.gc.ca/index-eng.php) (<http://hc-sc.gc.ca/index-eng.php>); the manufacturer's website [www.sandoz.ca](http://www.sandoz.ca), or by calling 1-800-361-3062.

This leaflet was prepared by Sandoz Canada Inc.

Last Revised <NOVEMBER-04-2020>

## READ THIS FOR SAFE AND EFFECTIVE USE OF YOUR MEDICINE

### PATIENT MEDICATION INFORMATION

**HYRIMOZ<sup>®</sup>** (pronounced <hye ri´ moze>  
**(adalimumab)**  
**40 mg / 0.8 mL Single-use Pre-filled SensoReady<sup>®</sup> Pen**

Read this carefully before you start taking **HYRIMOZ** and each time you get a refill. This leaflet is a summary and will not tell you everything about this drug. Talk to your healthcare professional about your medical condition and treatment and ask if there is any new information about **HYRIMOZ**.

**HYRIMOZ** is a biosimilar biologic drug (biosimilar) to the reference biologic drug HUMIRA<sup>®</sup>. A biosimilar is authorized based on its similarity to a reference biologic drug that was already authorized for sale.

#### Serious Warnings and Precautions

- **Allergic reactions:** If you/your child develop a severe rash, swollen face or difficulty breathing while taking HYRIMOZ, call your/your child's doctor right away.
- **Hepatosplenic T-cell lymphoma:** Very rare reports of hepatosplenic T-cell lymphoma (HSTCL), a rare serious lymphoma that is often fatal, have been identified in patients treated with adalimumab. Most patients had also been treated with other medications for Crohn's disease and the majority were in adolescent and young adult males. The link between HSTCL and adalimumab is not clear.
- **Other cancers:** There have been very rare cases of certain kinds of cancer in patients taking adalimumab or other TNF-blockers. Some patients receiving adalimumab have developed types of cancer called non-melanoma skin cancer. Tell your/your child's doctor if you/your child have a bump or open sore that does not heal. People with more serious rheumatoid arthritis that have had the disease for a long time may have a higher than average risk of getting a kind of cancer that affects the lymph system, called lymphoma. If you/your child take HYRIMOZ or other TNF-blockers, your/your child's risk may increase. There have been cases of lymphoma and other cancers, including unusual types, in children, adolescents and young adults taking TNF-blocking agents, including adalimumab, which sometimes resulted in death. For children and adults taking TNF-blocker medicines, the chances of developing lymphoma or other cancers may increase.
- **Lupus-like symptoms:** Some patients have developed lupus-like symptoms that got better after their treatment was stopped. If you/your child have chest pains that do not go away, shortness of breath, joint pain or a rash on your/your child's cheeks or arms that gets worse in the sun, call your/your child's doctor right away. Your/your child's doctor may decide to stop your/your child's treatment.

- **Nervous system diseases:** There have been rare cases of disorders that affect the nervous system of people taking adalimumab or other TNF-blockers. Signs that you/your child could be experiencing a problem affecting your/your child's nervous system include: numbness or tingling, problems with your/your child's vision, weakness in your/your child's legs, and dizziness.
- **Serious infections:** There have been rare cases where patients taking adalimumab or other TNF-blocking agents have developed serious infections. Some of these cases have been life-threatening. Such infections include tuberculosis, infections caused by bacteria or fungi, and bacterial infections that have spread throughout the body (sepsis). Infection causes include tuberculosis, legionellosis (a serious form of bacterial pneumonia), listeriosis (an infection that usually develops after eating food contaminated by bacteria called listeria), and very rare cases of hepatitis B infection relapse.
- **Blood problems:** In some instances, patients treated with TNF-blocking agents may develop low blood counts, such as anemia (low red blood cells) or low platelets. If you/your child develop symptoms such as persistent fever, bleeding, or bruising, you should contact your/your child's doctor right away.

#### **What is HYRIMOZ used for?**

**HYRIMOZ treatment should be started and supervised by specialist physicians experienced in the diagnosis and treatment of rheumatoid arthritis (RA), polyarticular juvenile idiopathic arthritis (JIA), psoriatic arthritis (PsA), ankylosing spondylitis (AS), adult Crohn's disease (CD), ulcerative colitis (UC), hidradenitis suppurativa (HS), psoriasis (Ps) or adult uveitis, and familiar with the HYRIMOZ efficacy and safety profile.**

HYRIMOZ is a medicine that is used in:

- adults with rheumatoid arthritis, which is an inflammatory disease of the joints.
- adults with psoriatic arthritis, which is an inflammatory disease of the joints and skin.
- adults with ankylosing spondylitis, which is a form of arthritis.
- adults with Crohn's disease, which is an inflammatory disease of the digestive tract.
- patients 2 years of age and older who have polyarticular juvenile idiopathic arthritis.
- adults with ulcerative colitis, which is an inflammatory disease of the bowel (colon).
- adults with moderate to severe hidradenitis suppurativa (HS) who have not responded to antibiotics. HS is a painful, progressive, chronic inflammatory skin disease that causes nodules, abscesses, sinus tracts and fistulas under the breasts, underarms, buttocks and groin.
- adults with psoriasis, which is an inflammatory disease of the skin. The doctor prescribed HYRIMOZ to reduce the signs and symptoms of your plaque psoriasis.
- adults with uveitis, which is an inflammatory disease of the eye.

Patients with rheumatoid arthritis, polyarticular juvenile idiopathic arthritis, psoriatic arthritis,

ankylosing spondylitis, hidradenitis suppurativa, psoriasis, or uveitis may be given other medicines for their disease before they are given HYRIMOZ. If you have ulcerative colitis or you have Crohn's disease, you will first be given other medicines. If you do not respond well enough to these medicines, you will be given HYRIMOZ to reduce the signs and symptoms of your/your child's disease.

### **How does HYRIMOZ work?**

HYRIMOZ is a fully human monoclonal antibody produced by cultured cells. Monoclonal antibodies are proteins that recognize and bind to other unique proteins. HYRIMOZ binds to a specific protein called TNF-alpha (also known as tumor necrosis factor). People with rheumatoid arthritis, psoriatic arthritis, ankylosing spondylitis, Crohn's disease, ulcerative colitis, hidradenitis suppurativa or psoriasis have too much of TNF-alpha in their bodies. The extra TNF-alpha in your/your child's body can attack normal healthy body tissues and cause inflammation, especially in the tissues of your bones, cartilage, joints, digestive tract and skin. By binding to TNF-alpha, HYRIMOZ decreases the inflammation process of these diseases.

HYRIMOZ helps reduce the signs and symptoms of rheumatoid arthritis, polyarticular juvenile idiopathic arthritis and psoriatic arthritis (such as pain and swollen joints), may help improve your/your child's ability to perform daily activities (such as getting dressed, walking and climbing stairs), and may help prevent further damage to your/your child's bones and joints. In addition, HYRIMOZ helps reduce the signs and symptoms of ankylosing spondylitis (back pain and morning stiffness), and adult Crohn's disease or ulcerative colitis (abdominal pain and diarrhea).

HYRIMOZ is also used to treat inflammatory lesions (nodules and abscesses) in adult patients with hidradenitis suppurativa.

HYRIMOZ also helps reduce the signs and symptoms of psoriasis (such as pain, itching and scaly patches on skin).

HYRIMOZ helps control uveitis by reducing the risk of inflammation and loss of vision in adult patients.

HYRIMOZ, however, can also lower your/your child's body's ability to fight infections. Taking HYRIMOZ can make you/your child more prone to getting infections or make any infection you/your child have worse.

### **What are the ingredients in HYRIMOZ?**

Medicinal ingredient: adalimumab

Non-medicinal ingredients: adipic acid, citric acid monohydrate, mannitol, polysorbate 80, sodium chloride and water for injection. Hydrochloric acid and sodium hydroxide are added as necessary to adjust pH.

### **HYRIMOZ comes in the following dosage forms:**

#### **Single-dose pre-filled HYRIMOZ SensoReady® Pen Injection:**

40 mg/0.8 mL of HYRIMOZ is provided by a single-dose pen (SensoReady® Pen), containing a

1 mL pre-filled glass syringe with a fixed 29-gauge, ½-inch needle and a black needle cover.

**Single-dose pre-filled syringe with BD UltraSafe Passive™ Needle Guard Injection:**

20 mg/0.4 mL of HYRIMOZ is provided by a single-dose, 1 mL pre-filled glass syringe with a needle guard and add-on finger flange, a fixed 29-gauge, ½-inch needle and a needle cover.

40 mg/0.8 mL of HYRIMOZ is provided by a single-dose, 1 mL pre-filled glass syringe with a needle guard and add-on finger flange, a fixed 29-gauge, ½-inch needle and a needle cover.

**Do not use HYRIMOZ if:**

You/your child should not take HYRIMOZ if you/your child have:

- an allergy to any of the ingredients in HYRIMOZ (see What are the ingredients in HYRIMOZ?).
- a serious infection such as tuberculosis, infections caused by bacteria or fungi, and bacterial infections that have spread throughout the body (sepsis).
- moderate to severe heart failure (NYHA class III/IV).

**To help avoid side effects and ensure proper use, talk to your healthcare professional before you take HYRIMOZ. Talk about any health conditions or problems you may have, including if:**

- you/your child have or have had any kind of infection including an infection that is in only one place in your/your child's body (such as an open cut or sore), or an infection that is in your/your child's whole body (such as the flu). Having an infection could put you/your child at risk for serious side effects from HYRIMOZ. If you are unsure, ask your/your child's doctor.
- you/your child have a history of infections that keep coming back or other conditions that might increase your/your child's risk of infections, including fungal infections.
- you/your child have ever had tuberculosis, or if you/your child have been in close contact with someone who has had tuberculosis. If you/your child develop any of the symptoms of tuberculosis (a dry cough that doesn't go away, weight loss, fever, night sweats) call your/your child's doctor right away. Your/your child's doctor will need to examine you/your child for tuberculosis and perform a skin test.
- you/your child resided or travelled to areas where there is a greater risk for certain kinds of infections such as tuberculosis, histoplasmosis, coccidioidomycosis, blastomycosis, or parasitic infections. These infections are caused by a bacteria or a fungus that can affect the lungs or other parts of your/your child's body. If you/your child take HYRIMOZ, these may become active or more severe. If you don't know if you/your child have lived in or travelled to an area where these infections are common, ask your/your child's doctor.
- you/your child have ever had liver injury or hepatitis B virus infection or are at risk of developing this infection. Signs and symptoms include the following: yellowing of the skin or eyes (jaundice), feeling of sickness, tiredness, loss of appetite, joint pain, fever, dark brown-coloured urine, vomiting, and abdominal pain. If you/your child experience any of these signs and symptoms, contact your/your child's doctor immediately. These symptoms may occur several months after starting therapy with HYRIMOZ.
- you/your child experience any numbness or tingling or have ever had a disease that affects your/your child's nervous system like multiple sclerosis or Guillain-Barré syndrome.

- you/your child have or have had heart failure.
- you/your child are scheduled to have major surgery or dental procedures.
- you/your child are scheduled to be vaccinated for anything. It is recommended that pediatric patients, if possible, be brought up to date with all immunizations according to current guidelines before starting HYRIMOZ.
- you/your child are taking other medicines for your/your child's rheumatoid arthritis, polyarticular juvenile idiopathic arthritis, psoriatic arthritis, ankylosing spondylitis, Crohn's disease, psoriasis, or other conditions. You/your child can take other medicines provided your/your child's doctor has prescribed them or has told you it is acceptable that you/your child take them while you/your child are taking HYRIMOZ. It is important that you tell your/your child's doctor about any other medicines you/your child are taking for other conditions (for example, high blood pressure medicine) before you/your child start taking HYRIMOZ.
- you/your child are taking other medicines for your/your child's Crohn's disease or other conditions. You/your child can take other medicines provided your/your child's doctor has prescribed them or has told you it is acceptable that you/ your child take them while you/your child are taking HYRIMOZ. It is important that you tell the doctor about any other medicines you/your child are taking for other conditions before you/your child start taking HYRIMOZ.
- you/your child are taking any over-the-counter drugs, herbal medicines and vitamin and mineral supplements.
- you/your child are pregnant or could become pregnant.
- you/your child are breast-feeding or plan to breast-feed.

***If you are not sure or have any questions about any of this information, ask your/your child's doctor.***

**Other warnings you should know about:**

Before starting, during and after treatment with HYRIMOZ, you/your child should be checked for active or inactive tuberculosis infection with a tuberculin skin test.

Any medicine can have side effects. Like all medicines that affect your/your child's immune system, HYRIMOZ can cause serious side effects (see Serious Warnings and Precautions box).

If you/your child received HYRIMOZ while pregnant, your/her baby may be at higher risk for getting an infection for up to approximately five months after the last dose of HYRIMOZ received during pregnancy. It is important that you tell your/her baby's doctors and other healthcare professionals about your/her HYRIMOZ use during pregnancy so they can decide when your/her baby should receive any vaccine.

**Tell your healthcare professional about all the medicines you take, including any drugs, vitamins, minerals, natural supplements or alternative medicines.**

**The following may interact with HYRIMOZ:**

You/your child should not take HYRIMOZ with:

- other TNF-blockers such as etanercept (Enbrel<sup>®</sup>), infliximab (Remicade<sup>®</sup>), certolizumab pegol (Cimzia<sup>®</sup>), or golimumab (Simponi<sup>®</sup>)

- abatacept (Orencia®)
- anakinra (Kineret®)

If you have questions, ask your/your child's doctor.

### **How to take HYRIMOZ:**

#### **Usual Dose:**

HYRIMOZ is administered by injection under the skin (by subcutaneous injection).

#### **Adults with Rheumatoid Arthritis, Psoriatic Arthritis or Ankylosing Spondylitis:**

- The recommended dose is 40 mg administered every other week as a subcutaneous injection.

#### **Patients, Aged 2 Years and Older, with Polyarticular Juvenile Idiopathic Arthritis:**

- weighing 10 kg to less than 30 kg: the recommended dose of HYRIMOZ is 20 mg every other week.
- weighing 30 kg or more: the recommended dose of HYRIMOZ is 40 mg every other week.

A dose of 10 mg every other week can be considered for patients weighing 10 to <15 kg. A different adalimumab product should be considered as there are no available presentations of HYRIMOZ capable of delivering 10 mg.

#### **Adults with Crohn's Disease or Ulcerative Colitis:**

- The recommended induction dose is 160 mg at Week 0 (dose can be administered as four injections in one day or as two injections per day for two consecutive days), followed by 80 mg at Week 2.
- The recommended maintenance dose regimen is 40 mg every other week beginning at Week 4.

#### **Adults with Hidradenitis Suppurativa:**

- The recommended initial dose is 160 mg, followed by 80 mg two weeks later. The first dose of 160 mg can be administered as four injections in one day or as two injections per day for two consecutive days. The second dose of 80 mg is given as two 40 mg injections in one day.
- The recommended maintenance dose regimen is 40 mg every week beginning four weeks after the initial dose.

#### **Adults with Psoriasis or Uveitis:**

- The recommended dose is an initial dose of 80 mg, followed by 40 mg given every other week starting one week after the initial dose.

## Your HYRIMOZ single-dose pre-filled SensoReady® Pen

The following instructions explain how to inject HYRIMOZ. Please read the instructions carefully and follow them step-by-step. You will be instructed by your/your child's doctor or assistant on the technique of injection. Do not attempt to inject until you are sure that you understand how to prepare and give the injection. After proper training, the injection can be self-administered or given by another person; for example, a healthcare professional, a family member or friend.

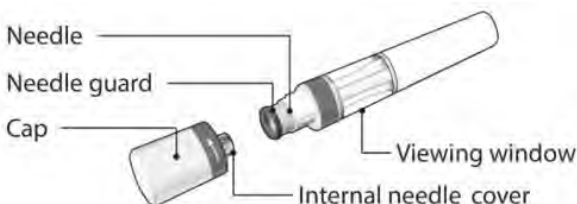

Figure A: HYRIMOZ SensoReady® Pen parts

In Figure A, the SensoReady® Pen is shown with the cap removed. **Do not** remove the cap until you are ready to inject.

### What do you need for your injection?

Included in your SensoReady® Pen carton is:

- a new and unused SensoReady® Pen. Each SensoReady® Pen contains 40 mg/0.8 mL of HYRIMOZ.



Figure B: HYRIMOZ SensoReady® Pen – included in the carton

Not included in your SensoReady® Pen carton are

- Alcohol swab
- Cotton ball or gauze
- Sharps disposal container



Figure C: items not included in the carton

See “8. Dispose of your used HYRIMOZ single-dose pre-filled SensoReady® Pen” at the end of this Instructions for Use.



## Before your injection

- For a more comfortable injection, take your SensoReady® Pen out of the refrigerator 15–30 minutes before injecting HYRIMOZ to allow it to reach room temperature.
- Look through the viewing window. The liquid should be clear, colorless to slightly yellowish and may contain small, translucent or white floating particles of protein.
- **Do not use** if you observe any other particulates and/or discolorations. You may see a small air bubble, which is normal. If you are concerned with the appearance of the solution, then contact your pharmacist for assistance.

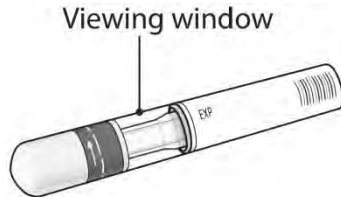

Figure D: Safety Checks before injection

- Look at the expiration date (EXP) on your SensoReady® Pen. Do not use your SensoReady® Pen if the expiration date has passed.
- Do not use if the safety seal has been broken

## Contact your pharmacist if the SensoReady® Pen fails any of these checks.

### 1. Choosing your injection site:

- The recommended injection site is the front of your thighs. You may also use the lower abdomen, but **not** the area 2 inches (5 cm) around your navel (belly button) (see *Figure E*).
- Choose a different site each time you give yourself an injection.
- Do not inject into areas where the skin is tender, bruised, red, scaly, or hard. Avoid areas with scars or stretch marks.
- If you have psoriasis, you should NOT inject directly into areas with psoriasis plaques

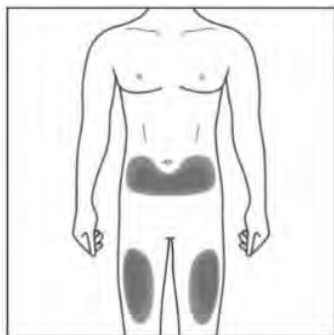

Figure E: choose your injection site

### 2. Cleaning your injection site:

- Wash your hands well with soap and water.

- Using a circular motion, clean the injection site with an alcohol swab. Leave it to dry before injecting (see *Figure F*).
- Do not touch the cleaned area again before injecting



*Figure F: clean your injection site*

**3. Removing the cap of your HYRIMOZ single-dose pre-filled SensoReady® Pen:**

- Only remove the cap when you are ready to use the SensoReady® Pen.
- Twist off the cap in the direction of the arrows (see *Figure G*).
- Once removed, throw away the cap. **Do not try to re-attach the cap.**
- Use your SensoReady® Pen within 5 minutes of removing the cap.
- You may see a few drops of drug come out of the needle. This is normal

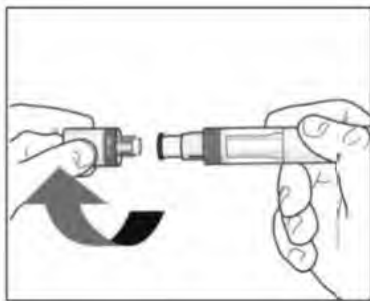

*Figure G: remove the cap*

**4. Holding your HYRIMOZ single-dose pre-filled SensoReady® Pen:**

- Hold your SensoReady® Pen at 90 degrees to the cleaned injection site (see *Figure H*).

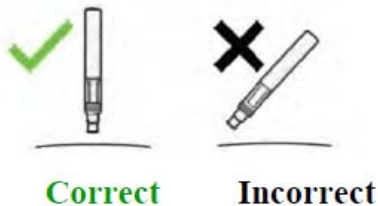

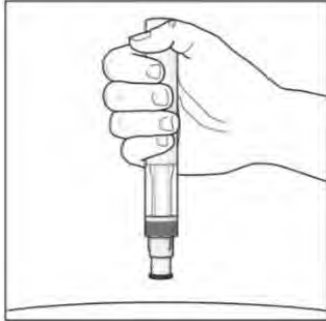

Figure H: hold your pen

## Your injection

### You must read this before injecting

During the injection you will hear **2 loud clicks**:

- The **1<sup>st</sup> click** indicates that the injection has **started**.
- Several seconds later a **2<sup>nd</sup> click** will indicate that the injection is **almost** finished.

You must keep holding your Sensoready<sup>®</sup> Pen firmly against your skin until you see a **green indicator** fill the window and stop moving.

### 5. Starting your injection:

- Press your Sensoready<sup>®</sup> Pen firmly against the skin to start the injection (see Figure I).
- The **1<sup>st</sup> click** indicates the injection has started.
- **Keep holding** your Sensoready<sup>®</sup> Pen firmly against your skin.
- The **green indicator** shows the progress of the injection

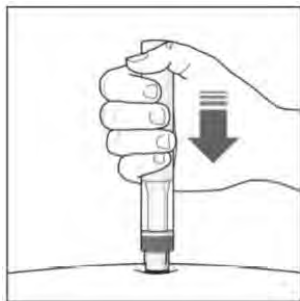

Figure I: start your injection

### 6. Completing your injection:

- Listen for the **2<sup>nd</sup> click**. This indicates the injection is **almost** complete.
- Check the **green indicator** fills the window and has stopped moving (see Figure J).
- The Sensoready<sup>®</sup> Pen can now be removed

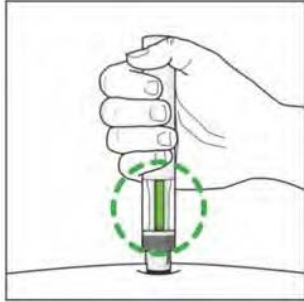

Figure J: complete your injection

### After your injection

#### 7. Check the green indicator fills the window (see Figure K):

- This means the medicine has been delivered. Contact your doctor if the green indicator is not visible.
- There may be a small amount of blood at the injection site. You can press a cotton ball or gauze over the injection site and hold it for 10 seconds. Do not rub the injection site. You may cover the injection site with a small adhesive bandage, if needed.

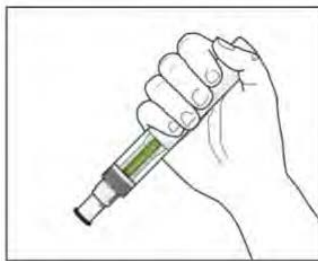

Figure K: check the green indicator

#### 8. Disposing of your used HYRIMOZ single-dose pre-filled SensoReady® Pen:

- Dispose of the used pens in a sharps container (closable, puncture-resistant container). For the safety and health of you and others, the pens must never be re-used.
- Do not throw away any medicines via wastewater or household waste. Ask your doctor or pharmacist how to throw away medicines you no longer use. These measures will help protect the environment. Any unused product or waste material should be disposed of in accordance with local requirements.

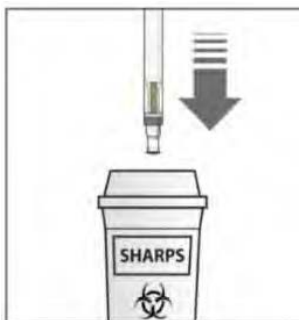

Figure L: dispose of your used pen

**Overdose:**

If you/your child accidentally inject HYRIMOZ more frequently than instructed, contact your/your child's doctor or local poison control centre right away.

If you think you have taken too much HYRIMOZ, contact your healthcare professional, hospital emergency department or regional poison control centre immediately, even if there are no symptoms.

**Missed Dose:**

If you/your child forget to give yourself/your child an injection, you/your child should inject the missed dose of HYRIMOZ as soon as you/your child remember. Then administer the next dose as you would have on the originally scheduled date.

**What are possible side effects from using HYRIMOZ?**

These are not all the possible side effects you may feel when taking HYRIMOZ. If you experience any side effects not listed here, contact your healthcare professional.

Like all medicines, HYRIMOZ can cause side effects. Most side effects are mild to moderate. However, some may be serious and require treatment. Tell your/your child's doctor immediately if you/your child experience any of the following:

- severe rash, hives or other signs of allergic reaction
- swollen face, hands, feet
- trouble breathing, swallowing
- sudden weight gain; this is possibly indicative of new or worsening heart failure
- bruising or bleeding very easily, looking very pale; this could mean a blood problem such as low red blood cells (anemia) or low platelets

Tell the doctor as soon as possible if you/your child notice any of the following:

- signs of infection such as fever, malaise, wounds, dental problems, burning on urination
- feeling weak or tired
- coughing
- tingling
- numbness
- double vision
- arm or leg weakness
- arm or leg pain, swelling or redness
- bump or open sore that does not heal
- red scaly patches or raised bumps that are filled with pus; this could be new or worsening hidradenitis suppurativa, new or worsening psoriasis or a skin infection
- alopecia (loss of hair)
- changes in the colour of the skin
- changes in the colour of your/your child's urine (dark or red)

- worsening of the appearance of a scar
- night sweats
- weight loss
- pain in the abdomen or chest

<b>Serious side effects and what to do about them</b>			
Symptom / effect	Talk to your healthcare professional		Stop taking drug and get immediate medical help
	Only if severe	In all cases	
<b>VERY COMMON</b> Injection site reaction		✓	
<b>COMMON</b> Cough and cold symptoms, including sore throat		✓	
Headache	✓		
Rash		✓	
Nausea		✓	
Pneumonia		✓	✓
Fever		✓	
Abdominal pain	✓		
<b>UNCOMMON</b> Tuberculosis		✓	✓
Other serious infections		✓	✓
Nerve disorder		✓	✓
Appendicitis		✓	✓
Blood clots: abdominal pain, chest pain, leg or arm pain with redness and swelling		✓	✓
Bladder infection (painful urination)		✓	✓
Hepatitis (jaundice [yellow skin, dark urine], abdominal pain, tiredness)		✓	✓

If you have a troublesome symptom or side effect that is not listed here or becomes bad enough to interfere with your daily activities, talk to your healthcare professional.

### **Reporting Side Effects**

You can report any suspected side effects associated with the use of health products to Health Canada by:

- Visiting the Web page on [Adverse Reaction Reporting](http://www.hc-sc.gc.ca/dhp-mps/medeff/report-declaration/index-eng.php) (<http://www.hc-sc.gc.ca/dhp-mps/medeff/report-declaration/index-eng.php>) for information on how to report online, by mail or by fax; or
- Calling toll-free at 1-866-234-2345.

*NOTE: Contact your health professional if you need information about how to manage your side effects. The Canada Vigilance Program does not provide medical advice.*

**Storage:**

Keep HYRIMOZ and all other medicines out of the reach of children.

Store between 2 and 8°C (in a refrigerator) in the original carton until ready to use. Do not freeze your HYRIMOZ Pen. **DO NOT FREEZE HYRIMOZ.** Do not store your HYRIMOZ Pen in extreme heat or cold. Protect from light. Refrigerated HYRIMOZ remains stable until the expiration date printed on the Pen. Do not use beyond the expiration date.

When needed, for example when you/your child are travelling, a HYRIMOZ Pen can be stored at room temperature (up to 25°C/77°F) for a single maximum period of 21 days.

Once taken out of the refrigerator for room temperature storage, a HYRIMOZ Pen must be used within 21 days, even if it is put back in the refrigerator. If not used within 21 days, the HYRIMOZ Pen must be discarded. You should record the date when the HYRIMOZ Pen is first removed from the refrigerator.

Care should be taken to avoid dropping or crushing the product as it contains a glass syringe.

**General Advice About Prescription Medicines**

Talk to your/your child's doctor or other healthcare provider if you have any questions about this medicine or your/your child's condition. Medicines are sometimes prescribed for purposes other than those listed in a **PATIENT MEDICATION INFORMATION** leaflet. If you have any concerns about this medicine, ask the doctor. The doctor or pharmacist can give you information about this medicine that was written for healthcare professionals. Do not use this medicine for a condition for which it was not prescribed. Do not share this medicine with other people.

**Keep HYRIMOZ and all medicines out of the reach of children.**

**If you want more information about HYRIMOZ:**

- Talk to your healthcare professional
- Find the full product monograph that is prepared for healthcare professionals and includes this Patient Medication Information by visiting the [Health Canada website](http://hc-sc.gc.ca/index-eng.php) (<http://hc-sc.gc.ca/index-eng.php>); the manufacturer's website [www.sandoz.ca](http://www.sandoz.ca), or by calling 1-800-361-3062.

This leaflet was prepared by Sandoz Canada Inc.

Last Revised <NOVEMBER-04-2020>

## READ THIS FOR SAFE AND EFFECTIVE USE OF YOUR MEDICINE

### PATIENT MEDICATION INFORMATION

**HYRIMOZ<sup>®</sup>** (pronounced <hye ri' moze>)  
(adalimumab)

**40 mg / 0.8 mL Single-use Prefilled Syringe with Needle Guard**

Read this carefully before you start taking **HYRIMOZ** and each time you get a refill. This leaflet is a summary and will not tell you everything about this drug. Talk to your healthcare professional about your medical condition and treatment and ask if there is any new information about **HYRIMOZ**.

**HYRIMOZ** is a biosimilar biologic drug (biosimilar) to the reference biologic drug HUMIRA<sup>®</sup>. A biosimilar is authorized based on its similarity to a reference biologic drug that was already authorized for sale.

#### Serious Warnings and Precautions

- **Allergic reactions:** If you/your child develop a severe rash, swollen face or difficulty breathing while taking HYRIMOZ, call your/your child's doctor right away.
- **Hepatosplenic T-cell lymphoma:** Very rare reports of hepatosplenic T-cell lymphoma (HSTCL), a rare serious lymphoma that is often fatal, have been identified in patients treated with adalimumab. Most patients had also been treated with other medications for Crohn's disease and the majority were in adolescent and young adult males. The link between HSTCL and adalimumab is not clear.
- **Other cancers:** There have been very rare cases of certain kinds of cancer in patients taking adalimumab or other TNF-blockers. Some patients receiving adalimumab have developed types of cancer called non-melanoma skin cancer. Tell your/your child's doctor if you/your child have a bump or open sore that does not heal. People with more serious rheumatoid arthritis that have had the disease for a long time may have a higher than average risk of getting a kind of cancer that affects the lymph system, called lymphoma. If you/your child take HYRIMOZ or other TNF-blockers, your/your child's risk may increase. There have been cases of lymphoma and other cancers, including unusual types, in children, adolescents and young adults taking TNF-blocking agents, including adalimumab, which sometimes resulted in death. For children and adults taking TNF-blocker medicines, the chances of developing lymphoma or other cancers may increase.
- **Lupus-like symptoms:** Some patients have developed lupus-like symptoms that got better after their treatment was stopped. If you/your child have chest pains that do not go away, shortness of breath, joint pain or a rash on your/your child's cheeks or arms that gets worse in the sun, call your/your child's doctor right away. Your/your child's



doctor may decide to stop your/your child's treatment.

- **Nervous system diseases:** There have been rare cases of disorders that affect the nervous system of people taking adalimumab or other TNF-blockers. Signs that you/your child could be experiencing a problem affecting your/your child's nervous system include: numbness or tingling, problems with your/your child's vision, weakness in your/your child's legs, and dizziness.
- **Serious infections:** There have been rare cases where patients taking adalimumab or other TNF-blocking agents have developed serious infections. Some of these cases have been life-threatening. Such infections include tuberculosis, infections caused by bacteria or fungi, and bacterial infections that have spread throughout the body (sepsis). Infection causes include tuberculosis, legionellosis (a serious form of bacterial pneumonia), listeriosis (an infection that usually develops after eating food contaminated by bacteria called listeria), and very rare cases of hepatitis B infection relapse.
- **Blood problems:** In some instances, patients treated with TNF-blocking agents may develop low blood counts, such as anemia (low red blood cells) or low platelets. If you/your child develop symptoms such as persistent fever, bleeding, or bruising, you should contact your/your child's doctor right away.

#### What is HYRIMOZ used for?

**HYRIMOZ treatment should be started and supervised by specialist physicians experienced in the diagnosis and treatment of rheumatoid arthritis (RA), polyarticular juvenile idiopathic arthritis (JIA), psoriatic arthritis (PsA), ankylosing spondylitis (AS), adult Crohn's disease (CD), ulcerative colitis (UC), hidradenitis suppurativa (HS), psoriasis (Ps) or adult uveitis, and familiar with the HYRIMOZ efficacy and safety profile.**

HYRIMOZ is a medicine that is used in:

- adults with rheumatoid arthritis, which is an inflammatory disease of the joints.
- adults with psoriatic arthritis, which is an inflammatory disease of the joints and skin.
- adults with ankylosing spondylitis, which is a form of arthritis.
- adults with Crohn's disease, which is an inflammatory disease of the digestive tract.
- patients 2 years of age and older who have polyarticular juvenile idiopathic arthritis.
- adults with ulcerative colitis, which is an inflammatory disease of the bowel (colon).
- adults with moderate to severe hidradenitis suppurativa (HS) who have not responded to antibiotics. HS is a painful, progressive, chronic inflammatory skin disease that causes nodules, abscesses, sinus tracts and fistulas under the breasts, underarms, buttocks and groin.
- adults with psoriasis, which is an inflammatory disease of the skin. The doctor prescribed HYRIMOZ to reduce the signs and symptoms of your plaque psoriasis.
- adults with uveitis, which is an inflammatory disease of the eye.

Patients with rheumatoid arthritis, polyarticular juvenile idiopathic arthritis, psoriatic arthritis,

ankylosing spondylitis, hidradenitis suppurativa, psoriasis, or uveitis may be given other medicines for their disease before they are given HYRIMOZ. If you have ulcerative colitis or you have Crohn's disease, you will first be given other medicines. If you do not respond well enough to these medicines, you will be given HYRIMOZ to reduce the signs and symptoms of your/your child's disease.

### **How does HYRIMOZ work?**

HYRIMOZ is a fully human monoclonal antibody produced by cultured cells. Monoclonal antibodies are proteins that recognize and bind to other unique proteins. HYRIMOZ binds to a specific protein called TNF-alpha (also known as tumor necrosis factor). People with rheumatoid arthritis, psoriatic arthritis, ankylosing spondylitis, Crohn's disease, ulcerative colitis, hidradenitis suppurativa or psoriasis have too much of TNF-alpha in their bodies. The extra TNF-alpha in your/your child's body can attack normal healthy body tissues and cause inflammation, especially in the tissues of your bones, cartilage, joints, digestive tract and skin. By binding to TNF-alpha, HYRIMOZ decreases the inflammation process of these diseases.

HYRIMOZ helps reduce the signs and symptoms of rheumatoid arthritis, polyarticular juvenile idiopathic arthritis and psoriatic arthritis (such as pain and swollen joints), may help improve your/your child's ability to perform daily activities (such as getting dressed, walking and climbing stairs), and may help prevent further damage to your/your child's bones and joints. In addition, HYRIMOZ helps reduce the signs and symptoms of ankylosing spondylitis (back pain and morning stiffness), and adult Crohn's disease or ulcerative colitis (abdominal pain and diarrhea).

HYRIMOZ is also used to treat inflammatory lesions (nodules and abscesses) in adult patients with hidradenitis suppurativa.

HYRIMOZ also helps reduce the signs and symptoms of psoriasis (such as pain, itching and scaly patches on skin).

HYRIMOZ helps control uveitis by reducing the risk of inflammation and loss of vision in adult patients.

HYRIMOZ, however, can also lower your/your child's body's ability to fight infections. Taking HYRIMOZ can make you/your child more prone to getting infections or make any infection you/your child have worse.

### **What are the ingredients in HYRIMOZ?**

**Medicinal ingredient:** adalimumab

**Non-medicinal ingredients:** adipic acid, citric acid monohydrate, mannitol, polysorbate 80, sodium chloride and water for injection. Hydrochloric acid and sodium hydroxide are added as necessary to adjust pH.

### **HYRIMOZ comes in the following dosage forms:**

#### **Single-dose pre-filled HYRIMOZ SensoReady® Pen Injection:**

40 mg/0.8 mL of HYRIMOZ is provided by a single-dose pen (SensoReady® Pen), containing a

1 mL pre-filled glass syringe with a fixed 29-gauge, ½-inch needle and a black needle cover.

**Single-dose pre-filled syringe with BD UltraSafe Passive™ Needle Guard Injection:**

20 mg/0.4 mL of HYRIMOZ is provided by a single-dose, 1 mL pre-filled glass syringe with a needle guard and add-on finger flange, a fixed 29-gauge, ½-inch needle and a needle cover.

40 mg/0.8 mL of HYRIMOZ is provided by a single-dose, 1 mL pre-filled glass syringe with a needle guard and add-on finger flange, a fixed 29-gauge, ½-inch needle and a needle cover.

**Do not use HYRIMOZ if:**

You/your child should not take HYRIMOZ if you/your child have:

- an allergy to any of the ingredients in HYRIMOZ (see What are the ingredients in HYRIMOZ?).
- a serious infection such as tuberculosis, infections caused by bacteria or fungi, and bacterial infections that have spread throughout the body (sepsis).
- moderate to severe heart failure (NYHA class III/IV).

**To help avoid side effects and ensure proper use, talk to your healthcare professional before you take HYRIMOZ. Talk about any health conditions or problems you may have, including if:**

- you/your child have or have had any kind of infection including an infection that is in only one place in your/your child's body (such as an open cut or sore), or an infection that is in your/your child's whole body (such as the flu). Having an infection could put you/your child at risk for serious side effects from HYRIMOZ. If you are unsure, ask your/your child's doctor.
- you/your child have a history of infections that keep coming back or other conditions that might increase your/your child's risk of infections, including fungal infections.
- you/your child have ever had tuberculosis, or if you/your child have been in close contact with someone who has had tuberculosis. If you/your child develop any of the symptoms of tuberculosis (a dry cough that doesn't go away, weight loss, fever, night sweats) call your/your child's doctor right away. Your/your child's doctor will need to examine you/your child for tuberculosis and perform a skin test.
- you/your child resided or travelled to areas where there is a greater risk for certain kinds of infections such as tuberculosis, histoplasmosis, coccidioidomycosis, blastomycosis, or parasitic infections. These infections are caused by a bacteria or a fungus that can affect the lungs or other parts of your/your child's body. If you/your child take HYRIMOZ, these may become active or more severe. If you don't know if you/your child have lived in or travelled to an area where these infections are common, ask your/your child's doctor.
- you/your child have ever had liver injury or hepatitis B virus infection or are at risk of developing this infection. Signs and symptoms include the following: yellowing of the skin or eyes (jaundice), feeling of sickness, tiredness, loss of appetite, joint pain, fever, dark brown-coloured urine, vomiting, and abdominal pain. If you/your child experience any of these signs and symptoms, contact your/your child's doctor immediately. These symptoms may occur several months after starting therapy with HYRIMOZ.
- you/your child experience any numbness or tingling or have ever had a disease that affects your/your child's nervous system like multiple sclerosis or Guillain-Barré syndrome.

- you/your child have or have had heart failure.
- you/your child are scheduled to have major surgery or dental procedures.
- you/your child are scheduled to be vaccinated for anything. It is recommended that pediatric patients, if possible, be brought up to date with all immunizations according to current guidelines before starting HYRIMOZ.
- you/your child are taking other medicines for your/your child's rheumatoid arthritis, polyarticular juvenile idiopathic arthritis, psoriatic arthritis, ankylosing spondylitis, Crohn's disease, psoriasis, or other conditions. You/your child can take other medicines provided your/your child's doctor has prescribed them or has told you it is acceptable that you/your child take them while you/your child are taking HYRIMOZ. It is important that you tell your/your child's doctor about any other medicines you/your child are taking for other conditions (for example, high blood pressure medicine) before you/your child start taking HYRIMOZ.
- you/your child are taking other medicines for your/your child's Crohn's disease or other conditions. You/your child can take other medicines provided your/your child's doctor has prescribed them or has told you it is acceptable that you/ your child take them while you/your child are taking HYRIMOZ. It is important that you tell the doctor about any other medicines you/your child are taking for other conditions before you/your child start taking HYRIMOZ.
- you/your child are taking any over-the-counter drugs, herbal medicines and vitamin and mineral supplements.
- you/your child are pregnant or could become pregnant.
- you/your child are breast-feeding or plan to breast-feed

***If you are not sure or have any questions about any of this information, ask your/your child's doctor.***

**Other warnings you should know about:**

Before starting, during and after treatment with HYRIMOZ, you/your child should be checked for active or inactive tuberculosis infection with a tuberculin skin test.

Any medicine can have side effects. Like all medicines that affect your/your child's immune system, HYRIMOZ can cause serious side effects (see Serious Warnings and Precautions box).

If you/your child received HYRIMOZ while pregnant, your/her baby may be at higher risk for getting an infection for up to approximately five months after the last dose of HYRIMOZ received during pregnancy. It is important that you tell your/her baby's doctors and other healthcare professionals about your/her HYRIMOZ use during pregnancy so they can decide when your/her baby should receive any vaccine.

**Tell your healthcare professional about all the medicines you take, including any drugs, vitamins, minerals, natural supplements or alternative medicines.**

**The following may interact with HYRIMOZ:**

You/your child should not take HYRIMOZ with:

- other TNF-blockers such as etanercept (Enbrel<sup>®</sup>), infliximab (Remicade<sup>®</sup>), certolizumab pegol (Cimzia<sup>®</sup>), or golimumab (Simponi<sup>®</sup>)

- abatacept (Orencia®)
- anakinra (Kineret®)

If you have questions, ask your/your child's doctor.

### **How to take HYRIMOZ:**

#### **Usual dose:**

HYRIMOZ is administered by injection under the skin (by subcutaneous injection).

#### **Adults with Rheumatoid Arthritis, Psoriatic Arthritis or Ankylosing Spondylitis:**

- The recommended dose is 40 mg administered every other week as a subcutaneous injection.

#### **Patients, Aged 2 Years and Older, with Polyarticular Juvenile Idiopathic Arthritis:**

- weighing 10 kg to less than 30 kg: the recommended dose of HYRIMOZ is 20 mg every other week.
- weighing 30 kg or more: the recommended dose of HYRIMOZ is 40 mg every other week.

A dose of 10 mg every other week can be considered for patients weighing 10 to <15 kg. A different adalimumab product should be considered as there are no available presentations of HYRIMOZ capable of delivering 10 mg.

#### **Adults with Crohn's Disease or Ulcerative Colitis:**

- The recommended induction dose is 160 mg at Week 0 (dose can be administered as four injections in one day or as two injections per day for two consecutive days), followed by 80 mg at Week 2.
- The recommended maintenance dose regimen is 40 mg every other week beginning at Week 4.

#### **Adults with Hidradenitis Suppurativa:**

- The recommended initial dose is 160 mg, followed by 80 mg two weeks later. The first dose of 160 mg can be administered as four injections in one day or as two injections per day for two consecutive days. The second dose of 80 mg is given as two 40 mg injections in one day.
- The recommended maintenance dose regimen is 40 mg every week beginning four weeks after the initial dose.

#### **Adults with Psoriasis or Uveitis:**

- The recommended dose is an initial dose of 80 mg, followed by 40 mg given every other week starting one week after the initial dose.

### **Your HYRIMOZ single-dose pre-filled syringe with needle guard and add-on finger flange**

The following instructions explain how to inject HYRIMOZ. Please read the instructions carefully and follow them step-by-step. You will be instructed by your/your child's doctor or assistant on

the technique of injection. Do not attempt to inject until you are sure that you understand how to prepare and give the injection. After proper training, the injection can be self-administered or given by another person; for example, a healthcare professional, a family member or friend.

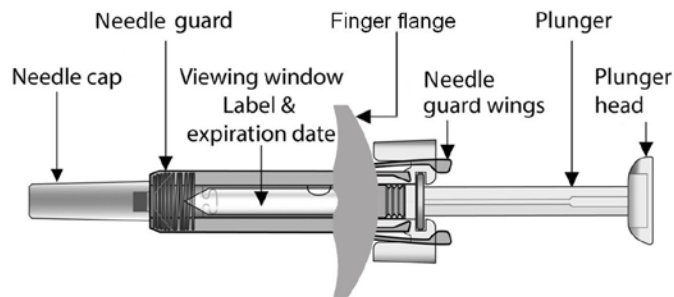

Figure A: HYRIMOZ pre-filled syringe with BD UltraSafe Passive™ Needle Guard and add-on finger flange

### What do you need for your injection?

Included in your HYRIMOZ pre-filled syringe carton is:

- a new HYRIMOZ pre-filled syringe (see Figure A). Each pre-filled syringe contains 40 mg/0.8 mL of HYRIMOZ.

Not included in you HYRIMOZ pre-filled syringe carton

- Alcohol swab
- Cotton ball or gauze
- Sharps disposal container

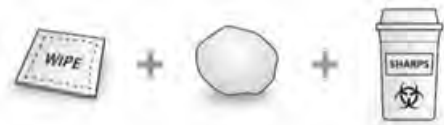

Figure B: items not included in the carton

See “**4. Dispose of used HYRIMOZ single-dose pre-filled syringes**” at the end of this Instructions for Use.

### Before your injection

#### Preparing the HYRIMOZ single-dose pre-filled syringe

- For a more comfortable injection, take the carton containing the HYRIMOZ pre-filled syringe out of the refrigerator and leave it unopened on your work surface for about 15 to 30 minutes so that it reaches room temperature.
- Wash your hands well with soap and water.
- Clean the injection site with an alcohol swab
- Remove the HYRIMOZ pre-filled syringe from the outer carton and take it out of the blister.
- Inspect the HYRIMOZ pre-filled syringe. Look through the viewing window. The liquid should be clear, colorless to slightly yellowish and may contain small, translucent or

white floating particles of protein. Do not use if any other particulates and/or discolorations are observed. If you are concerned with the appearance of the solution, then contact your pharmacist for assistance.

- **Do not use** the HYRIMOZ pre-filled syringe if it is broken or the needle guard is activated. Return the HYRIMOZ pre-filled syringe and the package it came in to the pharmacy.
- Look at the expiration date (EXP) on your HYRIMOZ pre-filled syringe. Do not use your HYRIMOZ pre-filled syringe if the expiration date has passed.

### 1. Choosing your injection site:

- The recommended injection site is the front of your thighs. You may also use the lower abdomen, but not the area 2 inches (5 cm) around your navel (belly button) (see Figure C).
- Choose a different site each time you give yourself an injection.
- Do not inject into areas where the skin is tender, bruised, red, scaly, or hard. Avoid areas with scars or stretch marks. If you have psoriasis, you should NOT inject directly into areas with psoriasis plaques

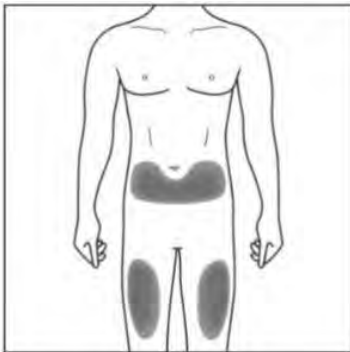

Figure C: choose your injection site

### 2. Cleaning your injection site:

- Using a circular motion, clean the injection site with a alcohol wipe. Leave it to dry before injecting (see Figure D).
- Do not touch the cleaned area before injecting



Figure D: clean your injection site

### 3. Giving your injection

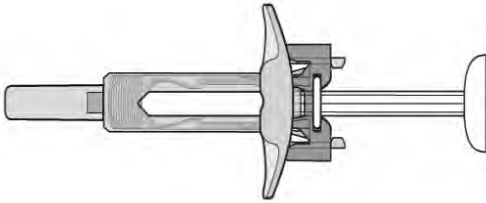

Figure E: needle guard is not activated – the single-dose pre-filled HYRIMOZ is ready for use

- In this configuration the needle guard is **NOT ACTIVATED**.
- The HYRIMOZ pre-filled syringe is ready for use (see Figure E).

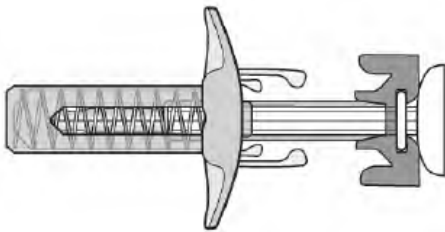

Figure F: needle guard is activated – do not use

- In this configuration the needle guard of your HYRIMOZ pre-filled syringe is **ACTIVATED**.
- **DO NOT USE** the pre-filled syringe (see figure F).
- Carefully pull the needle cap straight off to remove it from the single-dose pre-filled HYRIMOZ syringe (see Figure G).
- Discard the needle cap.
- You may see a drop of liquid at the end of the needle. This is normal.

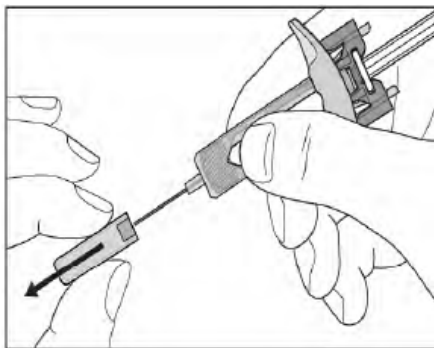

Figure G: pull the needle cap off

- Gently pinch the skin at the injection site (see Figure H).
- Insert the needle into your skin as shown.
- Push the needle all the way in to ensure that the medication can be fully administered



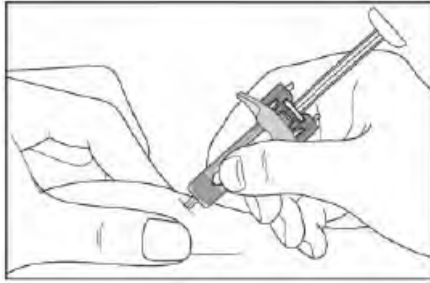

Figure H: insert the needle

- Hold the single-dose pre-filled HYRIMOZ syringe as shown (see *Figure I*).
- Slowly press down on the plunger as far as it will go, so that the plunger head is completely between the needle guard wings.
- Continue to press fully on the plunger for an additional 5 seconds. Hold the syringe in place for 5 seconds

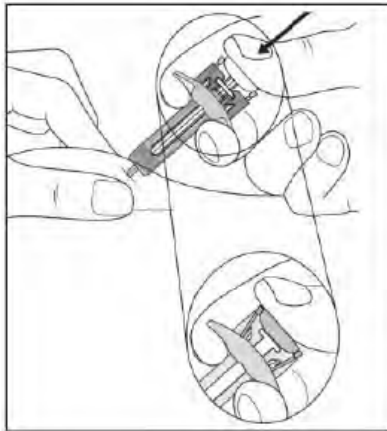

Figure I: hold the syringe

- **Keep the plunger fully pressed down** while you carefully lift the needle straight out from the injection site and let go off your skin (see *Figure J*).

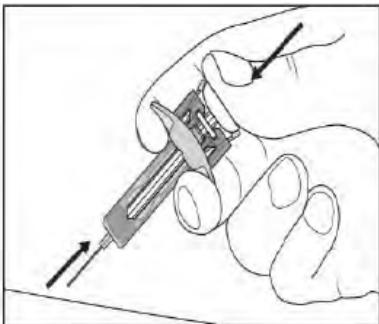

Figure J: lift the needle straight out

- Slowly release the plunger and allow the needle safety guard to automatically cover the exposed needle (see *Figure K*).
- There may be a small amount of blood at the injection site. You can press a cotton ball

or gauze onto the injection site and hold it for 10 seconds. Do not rub the injection site. You may cover the injection site with a small adhesive bandage, if needed

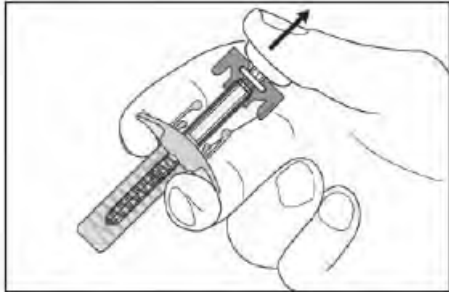

Figure K: slowly release the plunger

#### 4. Disposing of used single-dose pre-filled HYRIMOZ syringes

- Dispose of the used pens in a sharps container (closable, puncture-resistant container). For the safety and health of you and others, the pens must never be re-used.
- Do not throw away any medicines via wastewater or household waste. Ask your doctor or pharmacist how to throw away medicines you no longer use. These measures will help protect the environment. Any unused product or waste material should be disposed of in accordance with local requirements.



Figure L: dispose of your used pre-filled syringe

#### Overdose:

If you/your child accidentally inject HYRIMOZ more frequently than instructed, contact your/your child's doctor or local poison control centre right away.

If you think you have taken too much HYRIMOZ, contact your healthcare professional, hospital emergency department or regional poison control centre immediately, even if there are no symptoms.

#### Missed Dose:

If you/your child forget to give yourself/your child an injection, you/your child should inject the missed dose of HYRIMOZ as soon as you/your child remember. Then administer the next dose

as you would have on the originally scheduled date.

**What are possible side effects from using HYRIMOZ?**

These are not all the possible side effects you may feel when taking HYRIMOZ. If you experience any side effects not listed here, contact your healthcare professional.

Like all medicines, HYRIMOZ can cause side effects. Most side effects are mild to moderate. However, some may be serious and require treatment.

Tell your/your child’s doctor immediately if you/your child experience any of the following:

- severe rash, hives or other signs of allergic reaction
- swollen face, hands, feet
- trouble breathing, swallowing
- sudden weight gain; this is possibly indicative of new or worsening heart failure
- bruising or bleeding very easily, looking very pale; this could mean a blood problem such as low red blood cells (anemia) or low platelets

Tell the doctor as soon as possible if you/your child notice any of the following:

- signs of infection such as fever, malaise, wounds, dental problems, burning on urination
- feeling weak or tired
- coughing
- tingling
- numbness
- double vision
- arm or leg weakness
- arm or leg pain, swelling or redness
- bump or open sore that does not heal
- red scaly patches or raised bumps that are filled with pus; this could be new or worsening hidradenitis suppurativa, new or worsening psoriasis or a skin infection
- alopecia (loss of hair)
- changes in the colour of the skin
- changes in the colour of your/your child’s urine (dark or red)
- worsening of the appearance of a scar
- night sweats
- weight loss
- pain in the abdomen or chest

<b>Serious side effects and what to do about them</b>			
Symptom / effect	Talk to your healthcare professional		Stop taking drug and get immediate medical help
	Only if severe	In all cases	
<b>VERY COMMON</b> Injection site reaction		✓	
<b>COMMON</b> Cough and cold symptoms, including sore throat		✓	

Serious side effects and what to do about them			
Symptom / effect	Talk to your healthcare professional		Stop taking drug and get immediate medical help
	Only if severe	In all cases	
Headache	✓		
Rash		✓	
Nausea		✓	
Pneumonia		✓	✓
Fever		✓	
Abdominal pain	✓		
<b>UNCOMMON</b>			
Tuberculosis		✓	✓
Other serious infections		✓	✓
Nerve disorder		✓	✓
Appendicitis		✓	✓
Blood clots: abdominal pain, chest pain, leg or arm pain with redness and swelling		✓	✓
Bladder infection (painful urination)		✓	✓
Hepatitis (jaundice [yellow skin, dark urine], abdominal pain, tiredness)		✓	✓

If you have a troublesome symptom or side effect that is not listed here or becomes bad enough to interfere with your daily activities, talk to your healthcare professional.

<p><b>Reporting Side Effects</b></p> <p>You can report any suspected side effects associated with the use of health products to Health Canada by:</p> <ul style="list-style-type: none"> <li>• Visiting the Web page on <a href="http://www.hc-sc.gc.ca/dhp-mps/medeff/report-declaration/index-eng.php">Adverse Reaction Reporting</a> (<a href="http://www.hc-sc.gc.ca/dhp-mps/medeff/report-declaration/index-eng.php">http://www.hc-sc.gc.ca/dhp-mps/medeff/report-declaration/index-eng.php</a>) for information on how to report online, by mail or by fax; or</li> <li>• Calling toll-free at 1-866-234-2345.</li> </ul> <p><i>NOTE: Contact your health professional if you need information about how to manage your side effects. The Canada Vigilance Program does not provide medical advice.</i></p>
---

**Storage:**

Keep HYRIMOZ and all other medicines out of the reach of children.

Store between 2 and 8°C (in a refrigerator) in the original carton until ready to use. Do not freeze your HYRIMOZ pre-filled syringes. **DO NOT FREEZE HYRIMOZ.** Do not store your HYRIMOZ pre-filled syringes in extreme heat or cold. Protect from light. Refrigerated HYRIMOZ remains stable until the expiration date printed on the pre-filled syringe. Do not use beyond the

expiration date.

When needed, for example when you/your child are travelling, a HYRIMOZ pre-filled syringe can be stored at room temperature (up to 25°C/77°F) for a single maximum period of 21 days.

Once taken out of the refrigerator for room temperature storage, a HYRIMOZ pre-filled syringe must be used within 21 days, even if it is put back in the refrigerator. If not used within 21 days, the HYRIMOZ pre-filled syringe must be discarded. You should record the date when the HYRIMOZ pre-filled syringe is first removed from the refrigerator.

Care should be taken to avoid dropping or crushing the product as it contains a glass syringe.

### **General Advice About Prescription Medicines**

Talk to your/your child's doctor or other healthcare provider if you have any questions about this medicine or your/your child's condition. Medicines are sometimes prescribed for purposes other than those listed in a **PATIENT MEDICATION INFORMATION** leaflet. If you have any concerns about this medicine, ask the doctor. The doctor or pharmacist can give you information about this medicine that was written for healthcare professionals. Do not use this medicine for a condition for which it was not prescribed. Do not share this medicine with other people.

**Keep HYRIMOZ and all medicines out of the reach of children.**

**If you want more information about HYRIMOZ:**

- Talk to your healthcare professional
- Find the full product monograph that is prepared for healthcare professionals and includes this Patient Medication Information by visiting the [Health Canada website](http://hc-sc.gc.ca/index-eng.php) (<http://hc-sc.gc.ca/index-eng.php>); the manufacturer's website [www.sandoz.ca](http://www.sandoz.ca), or by calling 1-800-361-3062.

This leaflet was prepared by Sandoz Canada Inc.

Last Revised <NOVEMBER-04-2020>